

Sistemi decorativi
SMART



Smart è una soluzione intelligente progettata e realizzata dai nostri designers. Lo stile minimal di questo sistema si veste sia di colori classici quali bianco e argento satinato, sia di colori inediti e innovativi quali avorio e tortora, questi permettono un inusuale ma sorprendente connubio tra semplicità e originalità. I colori non sono l'unica sorpresa di questo sistema a corde guidate, lo Smart stupisce anche con un'inaspettata versatilità dovuta alla possibilità di realizzare sistemi con angoli a 90°, curve laterali con raggio 12 cm. e cinte ad ampio raggio.



Smart is a brilliant solution developed and built by our designers. Its minimal style dons both classic colours as white and satinized silver, and innovative ones as ivory and grey beige, which allow an unusual combination of simplicity and uniqueness. New colours aren't the only innovation in this pulley-guided cord system; Smart is also surprisingly versatile allowing 90° angles, lateral bends with 12 cm. radius and large radius curves.



Smart est une solution intelligente projetée et réalisée par nos designers. Le style minimal de ce système se pare soit de couleurs classiques, comme le blanc et l'argent satiné, soit de couleurs inédites, comme l'ivoire et le tourterelle, qui permettent un inhabituelle combinaison de simplicité et originalité. Les coloris ne sont pas la seule surprise de la tringle Smart, qui impressionne aussi par sa versatilité, due à la possibilité de réaliser des systèmes avec angles à 90°, courbes de rayon 12cm et cintres.

SISTEMA DECORATIVO IN ALLUMINIO

Aluminium decorative system for wave curtain

Système decorative en aluminium pour rideaux wave

Utilizzo

- Sistema decorativo in alluminio a strappo o con corde
- Indicato per tendaggi di larghezza massima cm. 500
- Apertura tenda centrale, laterale, multipla o asimmetrica
- Il sistema è indicato per installazioni sia a soffitto che a parete
- Il sistema di scorrimento delle corde d'azionamento in canali indipendenti permette di realizzare curve a 90°, centine ad ampio raggio, curve miste
- Lo scorrimento è garantito da scivoli autolubrificanti in HDPE polietilene oppure da scorrevoli con rotelle

Use

- System with hand or cord operation
- Suitable for curtains up to cm 500
- Opening can be: central, lateral, multiple or asymmetrical
- It can be fixed both at the ceiling or at the wall
- The cord sliding system in independent channels allows to realize 90° curves, big radius curves or mixed curves.
- Sliding is guaranteed by self-lubricating sliders in polyethylene HDPE, or by roller sliders.

Caratteristiche tecniche

- Profilo in lega d'alluminio estrusa 6060 T5 UNI EN 755-9
- Dimensioni mm. 17x26
- Raggio di curvatura:
 - ◆ r = cm. 12 per curva a 90° (per i colori 101-110-118)
 - ◆ r = cm. 50 per curva ad ampio raggio
- Finiture disponibili:
 - ◆ Bianco col 101/Avorio col 110/Tortora col 118/Nero col 125: verniciatura a polvere a base di resine poliesteri omologata a marchio QUALICOAT
 - ◆ Satinato col 103: ossidazione argento satinato
- Accessori in acetalica autolubrificante

Optional:

- Scivoli ONDA autolubrificanti in HDPE, distanziati da mm 60 o mm 80
- Scorrevoli in policarbonato con rotelle calibrate in acetalica autolubrificante
- Carrucole in acciaio con ruote in acetalica su perni in acciaio
- Sormonto in acetalica da cm. 7

Technical features

- Profile made of extruded aluminium alloy 6060 T5 UNI 9006/1
- Size mm. 17x26
- Curve radius:
 - ◆ r = cm. 12 for 90° curve (only for colours 101-110- 118)
 - ◆ r = cm. 50 for big radius curve
- Finiture disponibili:
 - ◆ White col 101/Ivory col 110/Grey Beige col 118/Black col. 125: Powder coating with polyester resins, homologated QUALICOAT
 - ◆ Satinized col 103: satinized silver oxidation

Optional:

- Wave gliss self-lubricant in HDPE, 60 or 80 mm. distance hooks
- Polycarbonate sliders with calibrated rollers in selflubricating acetalic POM
- Steel pulleys with acetal resin roller on steel pins
- 7cm acetal resin overlap
- Accessories in self-lubricating acetal resin

SISTEMA DECORATIVO IN ALLUMINIO

Aluminium decorative system for wave curtain

Système decorative en aluminium pour rideaux wave

■ ■ Utilisations

- Système décoratif en aluminium avec entraînement manuel ou par corde
- Convient aux rideaux de largeur maximale cm. 500
- Ouverture centrale, latérale, multiple ou asymétrique du rideau d'aliét
- Le système de glissement de chaîne d'entraînement dans les canaux indépendants vous permet de faire des courbes à 90 degrés, large-gamme, courbes mixtes
- Le glissement est garanti par des toboggans autolubrifiants dans le HDPE en polyéthylène ou par glisseurs avec roulettes

■ ■ Spécifications

- Profil en alliage d'aluminium extrudé 6060 T5 UNI EN 755-9
- Taille mm. 17x26
- Rayon de distorsion:
 - ◆ r = cm. 12 par courbe de 90 degrés
 - ◆ r = cm. 50 pour la courbe large-gamme
- Couleurs disponibles:
 - ◆ Blance col 101/Ivory col 110/Tourterelle col 118/Noir col 125: powder coating with polyester resins, homologated QUALI-COAT
 - ◆ Matt col. 103 – oxydation argentée satinée
- Accessoires en résine acétal autolubrifiante

Optional:

- Glisseurs wave autolubrifiantes en HDPE, avec distance 60mm ou 80mm
- Glisseurs en polycarbonate avec roulettes calibrées en résine acétal autolubrifiante
- Poulies en acier avec roulettes en résine acétal sur pivots en acier
- Barrette de chevauchement 7cm en résine acétal

Modelli

Models / Modèles

Modello BASIC



Art.2830MN



Art.2830CMN

Modello PLUS



Art.2830NE



Art.2830CNE

Colori

Colors / couleurs

-  101 Bianco / White / Blanc
-  103 Satinato / Mat / Satiné
-  110 Avorio / Ivory / Ivoire
-  118 Tortora / Grey Beige / Tourterelle
-  125 Nero / Black / Noir

Misure profili

profiles sizes / mesures des profils



Scivoli e scorrevoli

sliders / glisseurs



Art 3140



Art. 3144

Per Onda

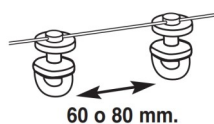

Art. 3220 - 3282 - 3223

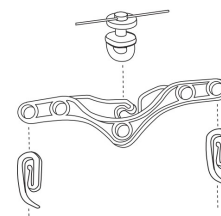

Art. 3266

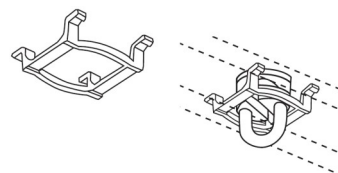

Art.3264



Art.3268

Onda
Wave / Wave

Apertura laterale

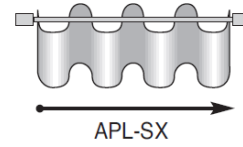
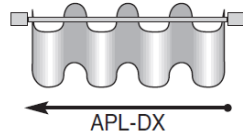
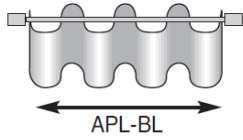
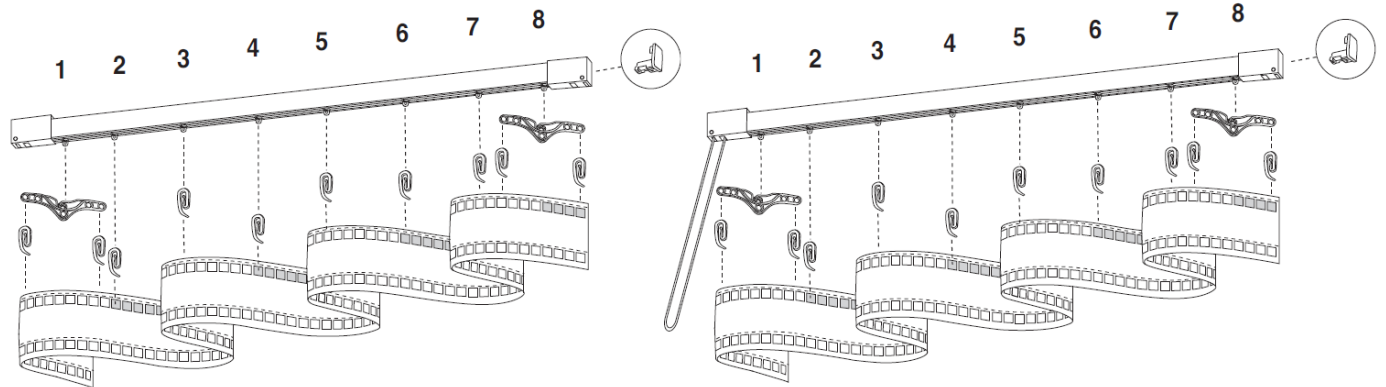

Apertura centrale

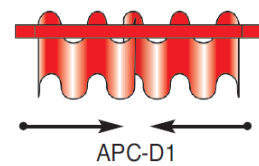
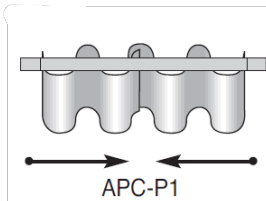
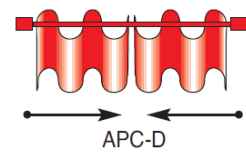
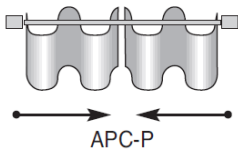
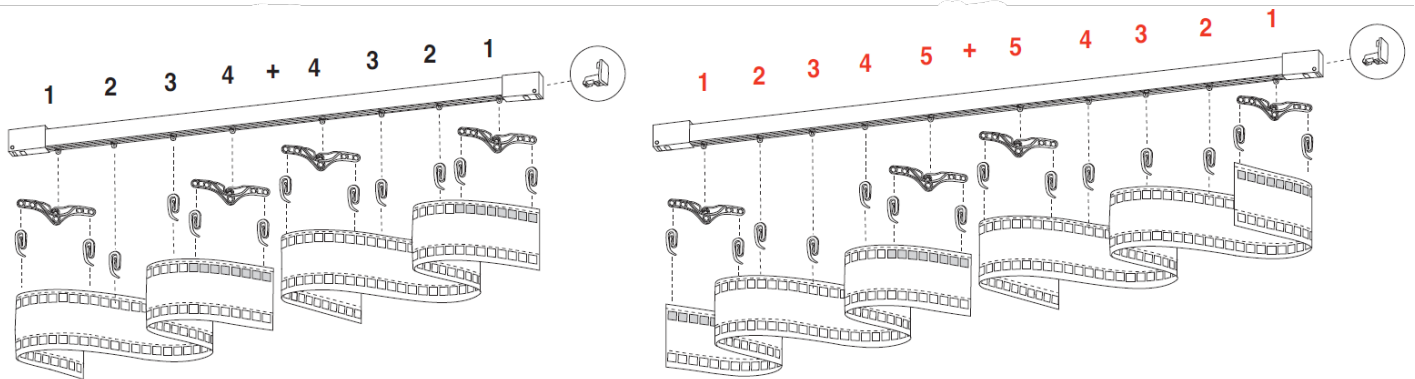

Installazioni e soluzioni di utilizzo

fixing / installations

Installazione a soffitto / ceiling fixing / au plafond

Mod. BASIC e PLUS - soffitto

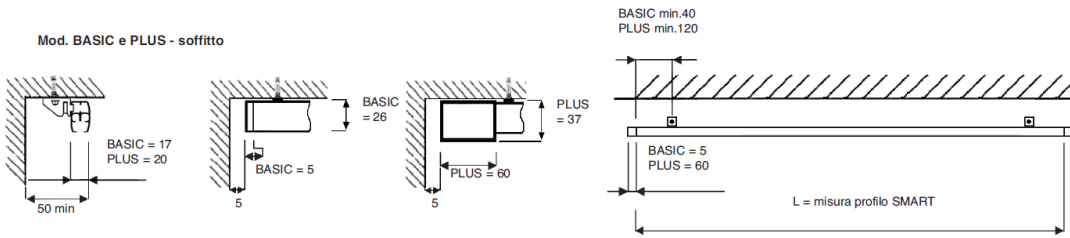

Mod. BASIC e PLUS - soffitto centinato

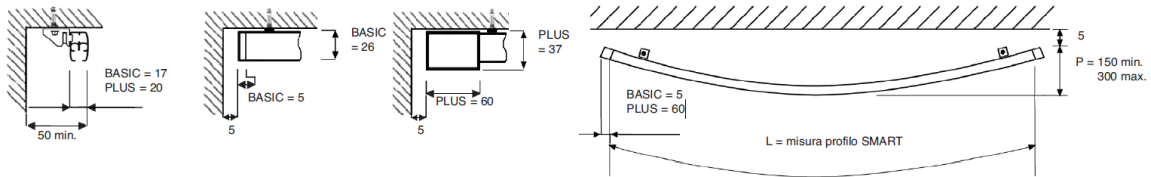

Mod. BASIC e PLUS - soffitto curve laterali

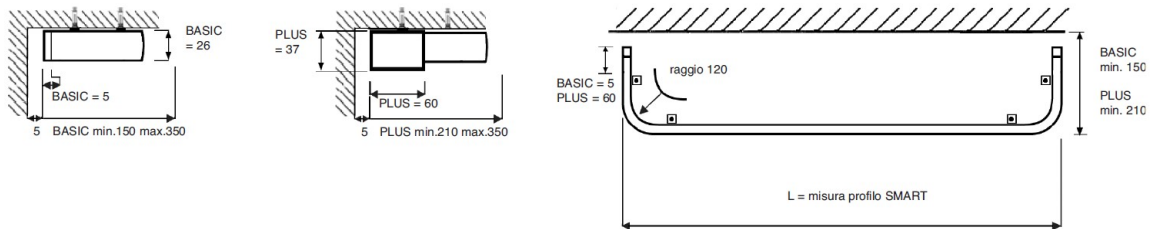

Mod. BASIC e PLUS - soffitto con angoli laterali

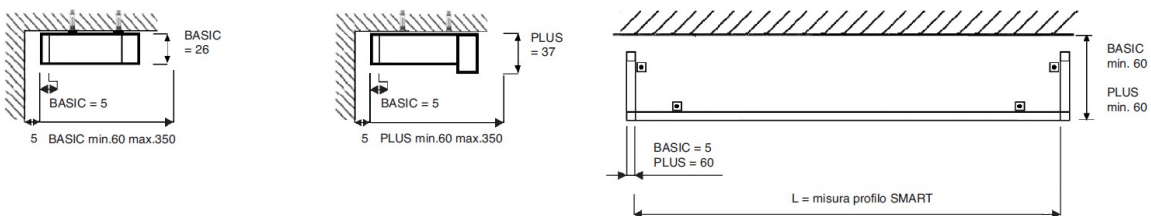

Installazione a parete / wall fixing / au mur

Mod. BASIC e PLUS - parete ARC 3230/SM

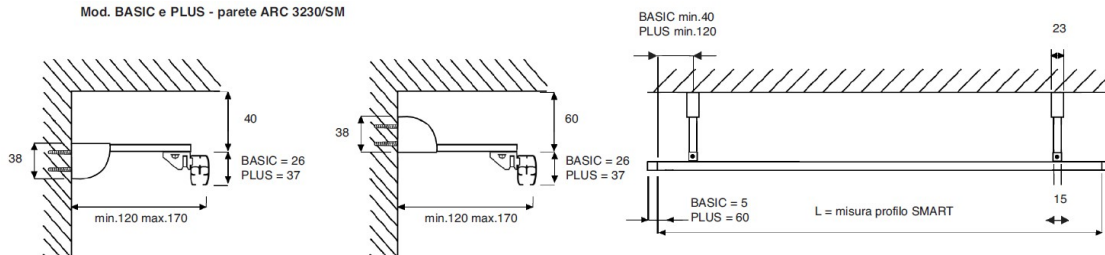

Mod. BASIC e PLUS - parete doppio ARC 3230

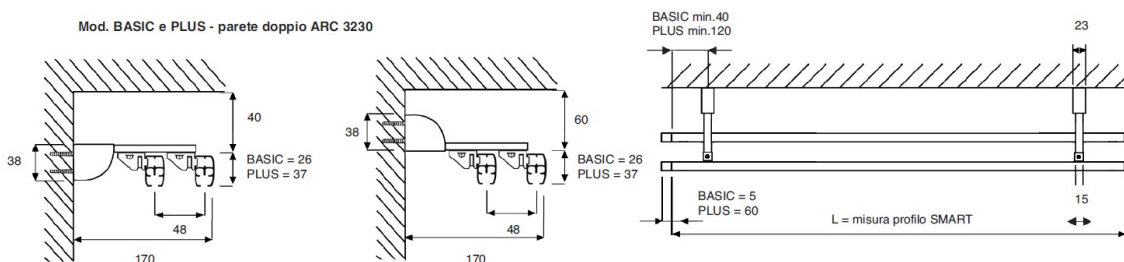

Esploso

exploded view / vue éclatée

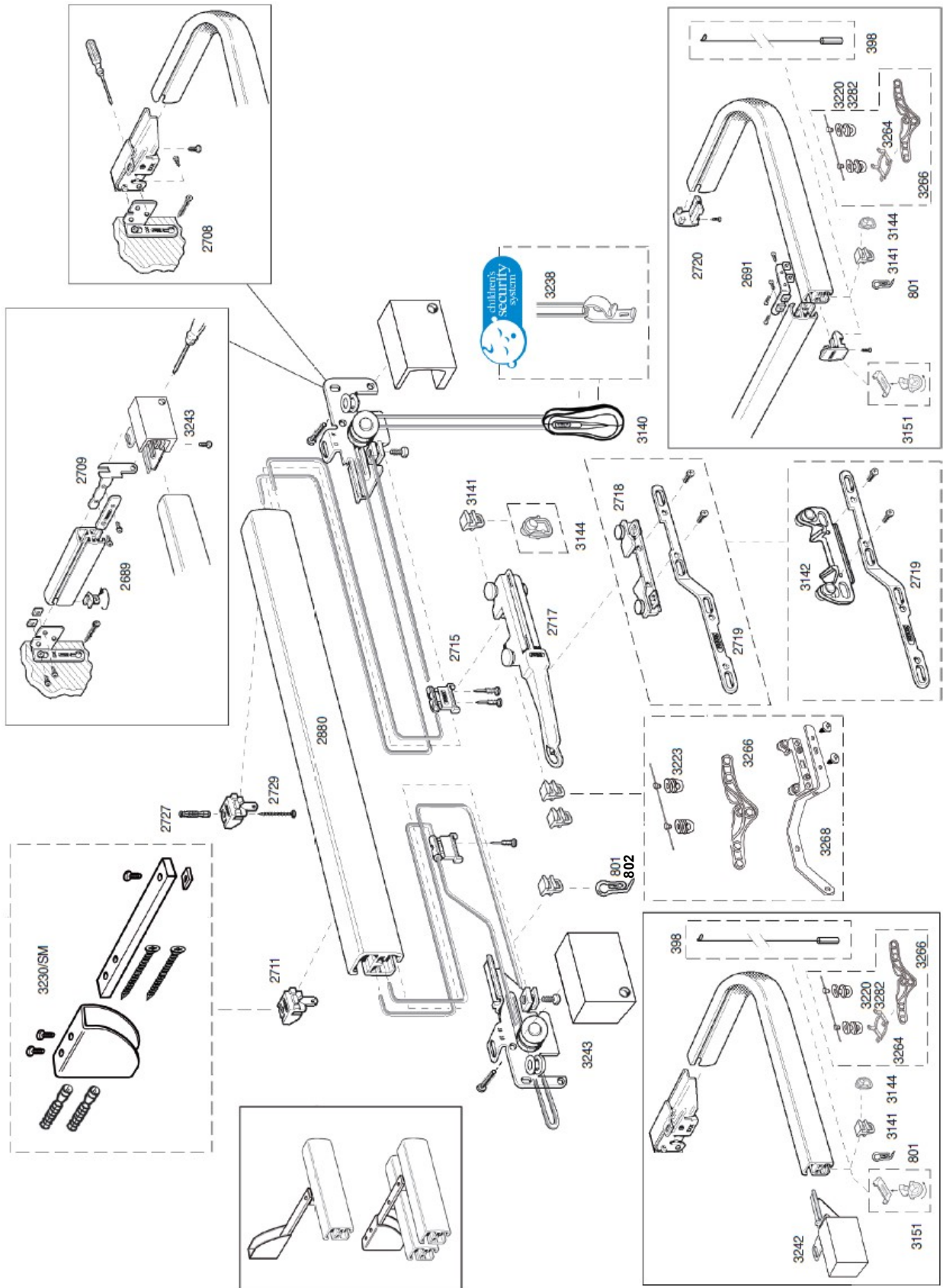



TENDE INTERNE ED ESTERNE

Rilox Italia Srl - Cap. Soc. €150.000,00 I./V.

Via Cascina Borniola, 15/A - 10036 Settimo Torinese (TO) - ITALY
Reg. Imprese Torino - C.F. - P. IVA - 10634150014 - R.E.A. 1149982

Ufficio Registro TORINO 2 - PEC: riloxitalia@pec.it

Tel:(+39) 011 262 5473 - Fax: (+39) 011 22 22 250

www.riloxitalia.it



@rilox.italia



#riloxitalia