



*Sistemi decorativi*  
**CHIC**



Chic è il sistema decorativo a strappo in alluminio di Rilox Italia pensato per tende arricciate e a onda.

Ha la straordinaria capacità di esaltare l'ambiente in cui è inserito grazie al design moderno e contemporaneo, le molteplici soluzioni personalizzate possibili (come, ad esempio, la vasta gamma di colori disponibili) e i due modelli di terminale tra cui scegliere. Questi ultimi, Moon e Nice, riflettono il carattere esclusivo dell'intero sistema decorativo grazie alla spiccata eleganza e ricercatezza.

Inoltre, grazie a Chic il design incontra la sostenibilità: ogni parte del processo di lavorazione, infatti, è stato eseguito nel totale rispetto della natura.



CHIC is Rilox Italia's aluminium decorative system for manual curtains, both traditional and wave.

Thanks to its modern design and to the wide colour range, Chic is able to enhance any type of environment. The matched endcaps Moon and Nice, simple and elegant at the same time, reflect the exclusive character of the whole decorative system.

Finally, this product combines design with sustainability: each part of the working process has been carried out in the total respect of nature.



CHIC est le système décoratif en aluminium de Rilox Italia pour rideaux manuels, soit traditionnels soit wave.

Grâce à son design moderne et à la large gamme de coloris, Chic peut enrichir n'importe quel type d'environnement. Les embouts assortis, Moon et Nice, simples et élégantes au même temps, reflètent le caractère exclusif de cet système décoratif.

Enfin, ce produit combine design et durabilité environnementale : chaque stade du cycle de production est, en effet, exécuté dans le plus total respect de la nature.

## SISTEMA DECORATIVO IN ALLUMINIO

### Aluminium decorative system for wave curtain

### Système decorative en aluminium pour rideaux wave

#### Utilizzo

- Sistema decorativo in alluminio a strappo o con corde
- Profili in aste da cm. 600
- Apertura tende centrale o laterale multipla o asimmetrica
- Arricciatura tradizionale oppure ONDA
- Il sistema è indicato per installazioni a soffitto, a parete e in libera sospensione
- Il sistema permette di realizzare nella versione a strappo, centine ad ampio raggio

#### Use

- Decorative aluminium system for hand or cord operation
- Suitable for curtains up to cm 600 width
- Opening can be: central, lateral, multiple or asymmetrical
- Traditional drape or WAVE
- Suitable for wall or ceiling installation and fixed with suspension rods
- The manual system can be wide-radius bent

#### Utilisations

- Système decorative en aluminium avec actionnement manuel or à cordon
- Convient aux rideaux de largeur maximale cm. 600
- Ouverture centrale, latérale, multiple ou asymétrique du rideau d'aliét
- Draperie traditionnelle ou wave
- Système adapté pour pose à paroi, à plafond ou suspendue avec tiges
- Le système, dans la version manuelle, peut être cintré

#### Caratteristiche tecniche

- Profilo in lega d'alluminio estruso 6060 T6 UNI 9006/1
- Dimensione mm. 17 x 34
- Canale di scorrimento mm. 6
- Finiture disponibili:
  - ◆ Bianco col. 101- verniciatura a polvere a base di resine poliesteri omologata a marchio QUALICOAT RAL 9010
  - ◆ Lucido col. 124 - lucidatura a specchio con ossidazione neutra di protezione
  - ◆ Satinato col. 103 - ossidazione argento satinato
  - ◆ Nero col. 125 - ossidazione nero lucido (solo profilo)
  - ◆ Oro col 130 - ossidazione oro semilucido (solo profilo)
- Scorrevoli autolubrificanti in HDPE
- Scivoli ONDA autolubrificanti in HDPE, distanziati da mm 60 o mm 80
- Scorrevoli in policarbonato con rotelle calibrate in acetalica autolubrificante
- **Carrucole in acetalica autolubrificante con ruote su perni in ottone**
- Guida tiro autolubrificanti in HDPE
- Doppio tiro con rotelle in policarbonato trasparente-bianco autolubrificante
- Asta sormonto in acciaio

#### Technical features

- Profile made of extruded aluminium alloy 6060 T5 UNI EN 755-9
- Size mm. 17 x 34
- Sliding channel mm. 6
  - ◆ White col 101. powder coating with polyester resins, homologated QUALICOAT white RAL 9010
  - ◆ Gloss finishing col. 124 – mirror polishing with protection neutral oxidation
  - ◆ Matt col. 103 – silver matt oxidation
  - ◆ Black col. 125 – gloss black oxidation (profile only)
  - ◆ Gold col. 130 – mid-gloss golden oxidation (profile only)
- Self-lubricating sliders in HDPE
- Wave sliders of self-lubricating HDPE, with 60mm or 80mm distance
- Polycarbonate sliders with calibrated rollers of self-lubricating acetalic resin
- Carrier with rollers of self-lubricating acetalic resin
- Double control with polycarbonate self-lubricating rollers, available in white or transparent
- Steel overlap

## SISTEMA DECORATIVO IN ALLUMINIO

### Aluminium decorative system for wave curtain

### Système decorative en aluminium pour rideaux wave

#### ■ ■ Utilisations

- Système decorative en aluminium avec actionnement manuel or à cordon
- Convient aux rideaux de largeur maximale cm. 600
- Ouverture centrale, latérale, multiple ou asymétrique du rideau d'aliét
- Draperie traditionnelle ou wave
- Système adapté pour pose à paroi, à plafond ou suspendue avec tiges
- Le système, dans la version manuelle, peut être cintré

#### ■ ■ Spécifications

- Profil en alliage d'aluminium extrudé 6060 T5 UNI EN 755-9
- Taille mm. 17 x 34
- Canal de glissement mm. 6
- Couleurs disponibles:
  - ◆ Blance col 101: Poudre PAINT à base de résines de polyester approuvée par la marque QUALICOAT WHITE RAL 9010
  - ◆ Brillant col. 124 – polissage miroir avec oxydation neutral de protection
  - ◆ Satiné col. 103 – oxydation argentée satinée
  - ◆ Noir col. 125 – oxydation noir brillant (seulement le profil)
  - ◆ Or col. 130 – oxydation dorée semi-brillante (seulement le profil)
- Glisseurs wave autolubrifiantes en HDPE
- Glisseurs wave autolubrifiantes en HDPE, avec distance 60mm ou 80mm
- Glisseurs en polycarbonate avec roulettes calibrées en résine acétal autolubrifiante
- Conducteur autolubrifiante en HDPE
- Double contrôle avec roulettes autolubrifiantes en polycarbonate, disponibles en blanc ou transparent
- Chevauchement en acier

## Modelli

Models / Modèles

Modello MOON



Art.2830MN



Art.2830CMN



Art.2830M1MN



Art.2830M2MN

Modello NICE



Art.2830NE



Art.2830CNE



Art.2830M1NE



Art.2830M3NE

## Colori

Colors / couleurs

	101 Bianco / White / Blanc
	103 Satinato / Mat / Satiné
	124 Lucido / Polished / Brilliant
	125 Nero / Black / Noir
	130 Oro/ Golden/ Or

## Misure profili

profiles sizes / mesures del profils

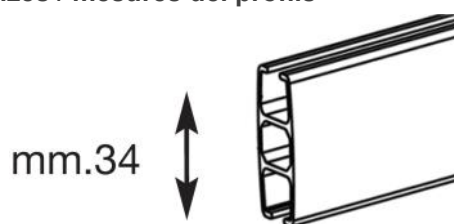

## Scivoli e scorrevoli

sliders / glisseurs



Art 3140



Art. 3144

Per Onda

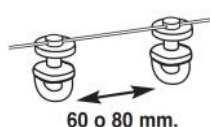

Art. 3220 - 3282 - 3223

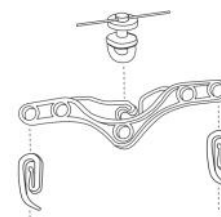

Art. 3266

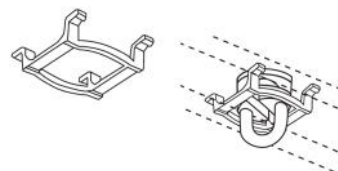

Art.3264

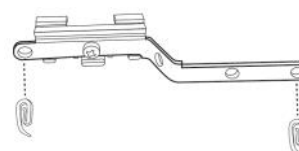

Art.2684

# Onda

Wave / Wave

\*attenzione: non disponibile per 2830M2MN e 2830M2NE / Warning: not for 2830M2MN e 2830M2NE / Attention: n'est pas pour 2830M2MN e 2830M2NE

## Apertura laterale

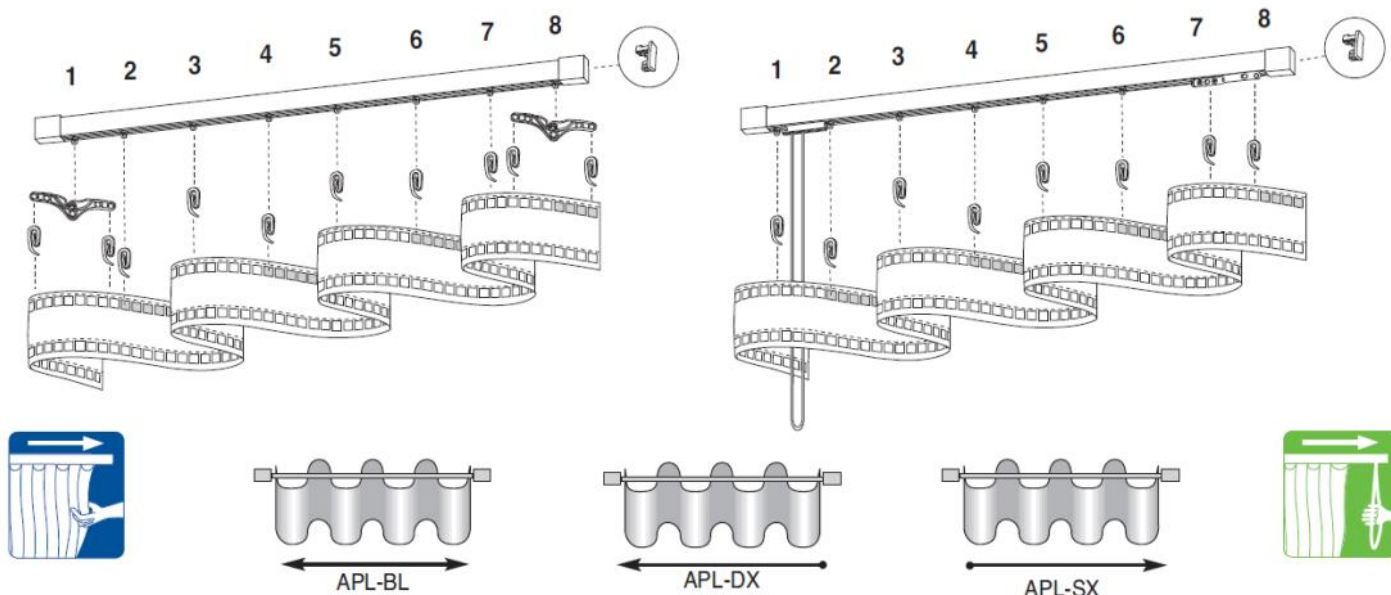

## Apertura centrale

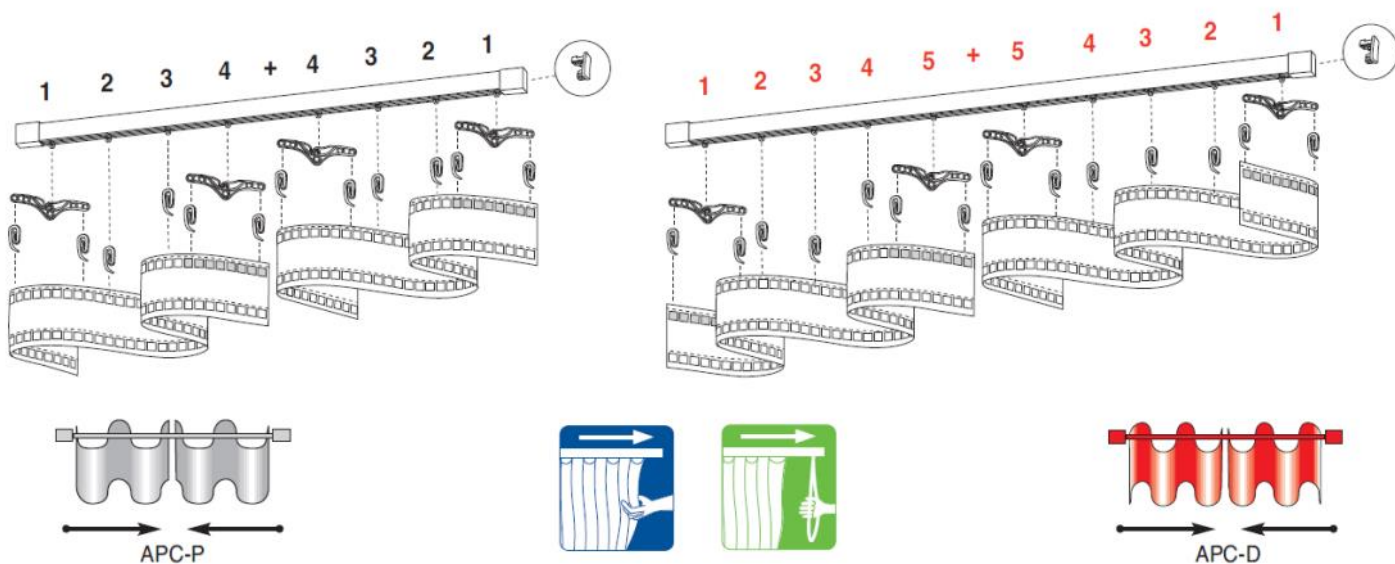

# Installazioni e soluzioni di utilizzo

fixing / installations

## Installazione a soffitto / ceiling fixing / au plafond

Mod. MOON e NICE - soffitto

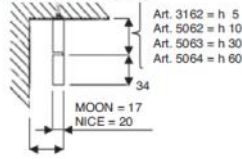

40 Min

Art. 3162 = 40 min.  
Art. 5062 = 40 min.  
Art. 5063 = 45 min.  
Art. 5064 = 45 min.

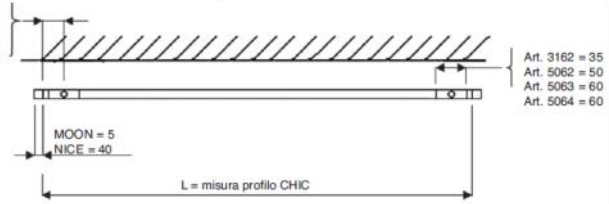

Mod. MOON e NICE - soffitto cernato

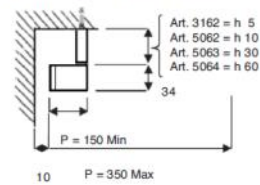

10

P = 350 Max

Art. 3162 = 40 min.  
Art. 5062 = 40 min.  
Art. 5063 = 45 min.  
Art. 5064 = 45 min.

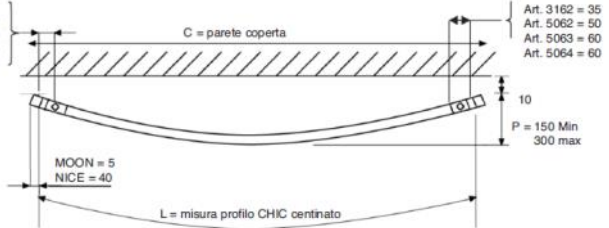

## Installazione a parete / wall fixing / au mur

Mod. MOON e NICE - parete ARC 3230

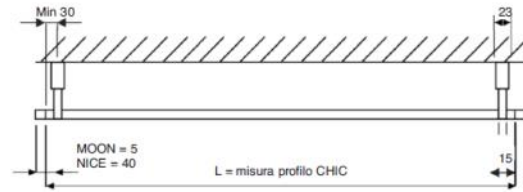
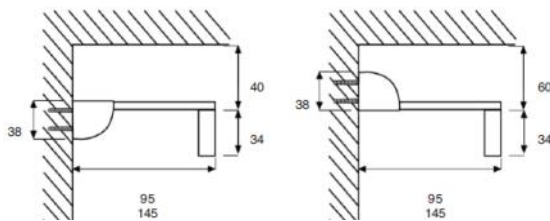

Mod. MOON e NICE - parete doppio ARC 3230

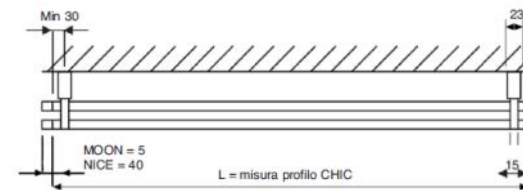
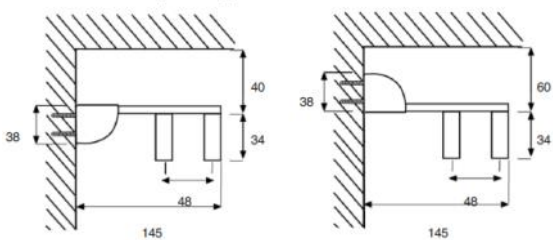

Mod. MOON e NICE - parete con art. 5060-5061

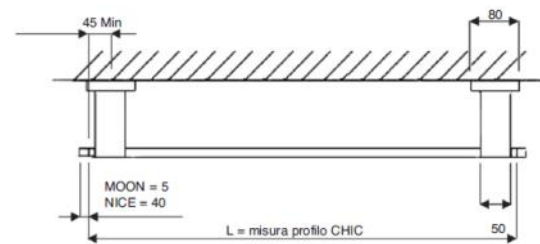
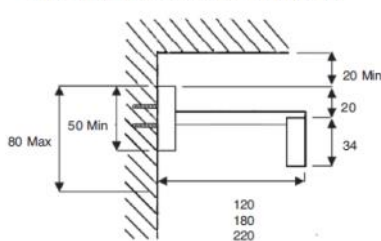

Mod. MOON e NICE - parete con art. 5065-5066

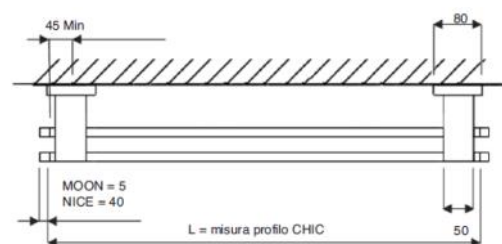
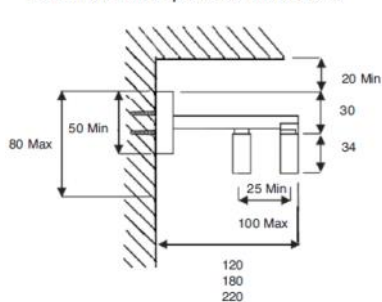

# Esploso

exploded view / vue éclatée

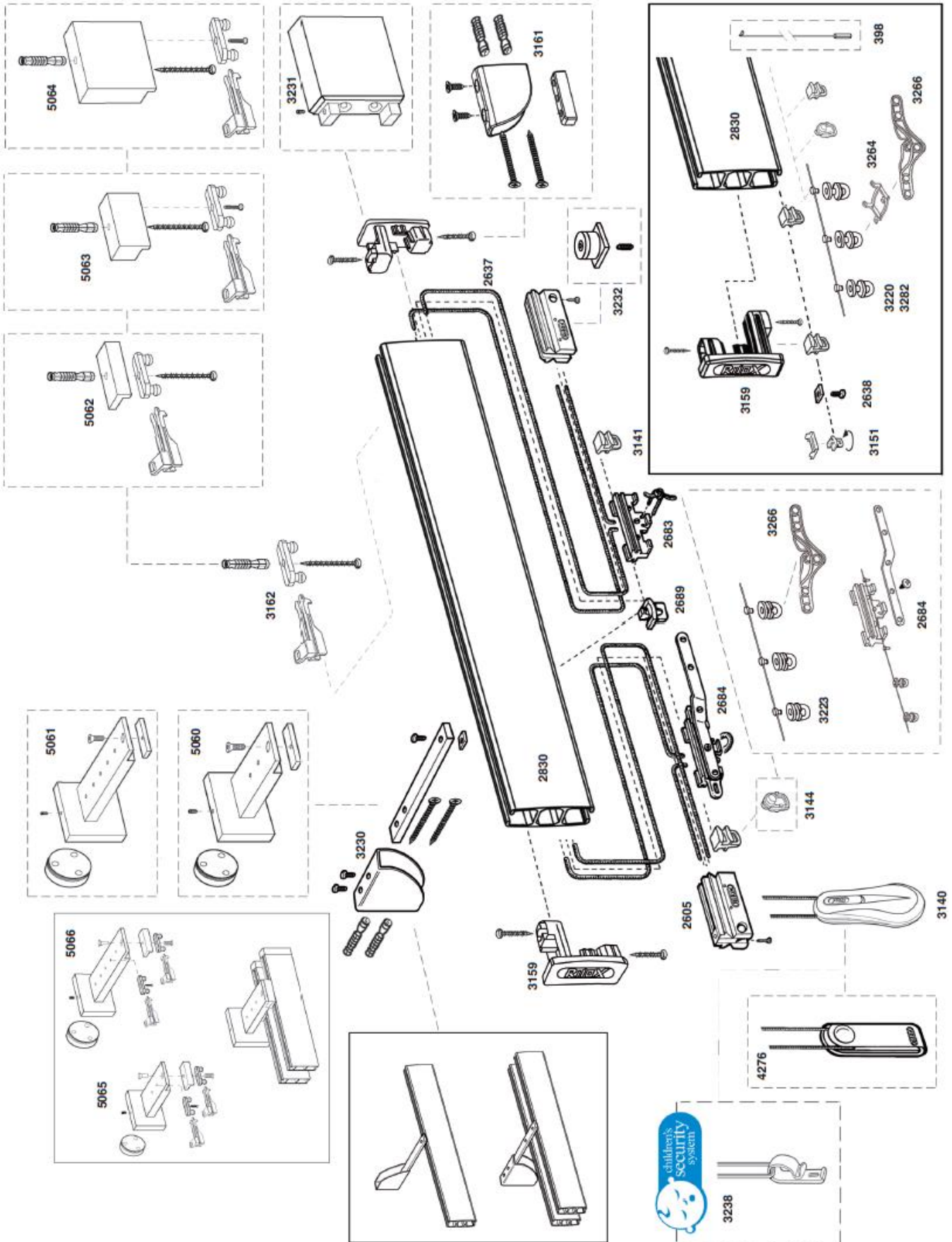



TENDE INTERNE ED ESTERNE

**Rilox Italia Srl** - Cap. Soc. €150.000,00 I./V.

Via Cascina Borniola, 15/A - 10036 Settimo Torinese (TO) - ITALY  
Reg. Imprese Torino - C.F. - P. IVA - 10634150014 - R.E.A. 1149982  
Ufficio Registro TORINO 2 - PEC: riloxitalia@pec.it  
Tel:(+39) 011 262 5473 - Fax: (+39) 011 22 22 250

[www.riloxitalia.it](http://www.riloxitalia.it)



@rilox.italia



#riloxitalia