



Hi-tech system
GO-SIMPLY 3090C40



Go-Simply è un sistema motore adatto a tendaggi fino a 40 kg di peso con una alimentazione da 220V (in linea con la tensione domestica presente solitamente nelle abitazioni). Di semplice utilizzo, è dotato di finecorsa di facile programmazione - con la possibilità di "autocalibrazione" - e della funzione Touch&Go, per azionare la tenda con un tocco.

È fornito di radio frequenza integrata, la quale permette l'utilizzo del motore tramite telecomando o pulsante a parete. È inoltre possibile azionare il motore attraverso l'applicazione per smartphone Go-App e collegarlo agli assistenti vocali disponibili sul mercato. Per di più, è stato ideato con predisposizione alla domotica tramite comando a contatti puliti.

È il sistema ideale per ambienti di piccole e medio-grandi dimensioni, come nel caso di barche, uffici, stanze di ospedale e d'albergo.



Go-Simply is a motorized system suitable for curtains up to 40kg and supplied with a 220V (consistent with the usual houses voltage). This system is very user-friendly: its end-run positions are easy programmable and can also be set through a self-calibration program. Possibility of setting the Touch&Go function, for operating the curtain with a simple touch.

The integrated radiofrequency allows to use both the remote control and the wall switch. It is also possible to operate the motor through the smartphone Go-App and to connect it to the voice assistants available on the market.

In addition, the system is pre-set for home-automation through dry-contact control.

It is the ideal system for small and medium environments, like boats, offices, hospital and hotel rooms.



Go-Simply est un système motorisé adapté pour rideaux jusqu'à 40kg et qui fonctionne sur 220V (en ligne avec la tension domestique habituelle). L'utilisation est très simple, car les fins de course se programment très facilement et ils peuvent aussi être réglés automatiquement à travers un procès de auto calibration. Il est aussi possible d'activer la fonction Touch&Go pour actionner les rideaux avec un simple touche.

La radiofréquence intégrée permet de contrôler le système soit avec la télécommande soit avec le bouton à paroi. On peut aussi actionner le moteur depuis le smartphone grâce à l'application Go-App et le connecter aux assistants vocaux disponibles sur le marché.

Enfin, le système est pré-réglé pour la maison intelligente via dispositif à contact sec.

Il s'agit du produit idéal pour environnements petits, comme les bateaux, les bureaux et les chambres d'hôpital et d'hôtel.

SISTEMA MOTORE PER TENDE FINO A 40KG

Motorized system for curtains up to 40kg

Système motorisé pour rideaux jusqu'à 40kg

Utilizzo

- Sistema motorizzato ideale per tendaggi medio grandi presso abitazioni, alberghi, barche, ospedali, uffici.
- Movimento silenzioso 48 decibel
- “Fine corsa” di facile programmazione con funzione “auto-calibrazione”
- Aperture disponibili: centrale, laterale, asimmetrica, multipla
- In caso di interruzione di corrente è possibile spostare le tende a strappo (al ritorno della corrente, se necessario, rilanciare l'autocalibrazione)
- Possibile realizzazione di pieghe

Comandi:

- Touch&Go (Tocca e vai)
- Pulsanti e domotica Somfy
- Radio frequenza integrata
- Go-APP gestione da remoto e vocale
- Predisposizione alla domotica con comando a contatti puliti

Use

- Motorized system ideal for big and medium curtains in houses, hotels, boats, hospitals, offices
- Silent operation 48 Decibel
- Easy-programming of end positions with “auto-calibration function”
- Opening can be: central, lateral, asymmetrical or multiple
- In case of power cut, it allows the curtain to be operated manually (when the current returns it may be necessary to restart calibration)
- The system allows you to realize 90° curves

Controls:

- Touch&Go and
- Wall switch and Somfy remote operation
- Radio remote control
- Go-App for remote and vocal operation
- Prepared for smart-home operation through dry contact actuator

Utilisations

- Système motorisé idéal pour rideaux demis et grands chez logements, hôtels, bateaux, bureaux.
- Fonctionnement silencieux 48 Decibel
- Programmation facile du fin de course grâce à la fonction de auto-calibration
- Ouverture centrale, latérale, asymétrique ou multiple du rideau d'aliet
- Le système permet, en cas de coupure de courant, d'actionner le rideau manuellement
- Le système vous permet de faire des courbes à 90 degrés

Actionnement:

- Touch&Go
- Bouton à contact et domotique Somfy
- Télécommande radio
- Go-App pour gestion à distance et vocale
- Préparé pour domotique avec contrôle à contact sec

Caratteristiche tecniche

- Profilo in lega d'alluminio estrusa 6060 T5 UNI EN 755-9
- Dimensioni mm. 26x32
- Portata massima totale 40 kg
- Larghezza massima cm. 800
- Alimentazione 110-240V/24Vcc
- Potenza minima assorbita 1,5A—60W, Omologato CE—IP20
- Velocità di scorrimento 8cm/s
- Canale di scorrimento mm. 6
- Colori disponibili:
 - ◆ verniciatura a polvere a base di resine poliesteri omologata a marchio QUALICOAT BIANCO RAL 9010
- Carrucole per guida nastro con base in ottone
- Nastro di movimentazione mm. 10
- Sormonto in acciaio da cm. 9
- Accessori in acetalica autolubrificante

Technical features

- Profile made of extruded aluminium alloy 6060 T5 UNI EN 755-9
- Size mm: 26x32
- Maximum weight capacity 40kg
- Maximum width cm. 800
- Power 110-240V/24Vcc
- Power consumption 1,5A—60W minimum, certified CE-IP20
- Sliding speed 8 cm/s
- Sliding channel mm.6
- Available colours:
 - ◆ powder coating with polyester resins, homologated QUALICOAT white RAL 9010
- Tape-guide pulleys with brass base.
- Tape width mm.10
- Steel overlap cm.9
- Accessories in self-lubricating acetal resin

Spécifications

- Profil en alliage d'aluminium extrudé 6060 T5 UNI EN 755-9
- Taille mm. 26x32
- Charge maximum 40 kg
- Largeur maximum: 800 cm
- Alimentation 110-240V/24Vcc
- Puissance absorbée 1,5A—60W minimum, homologué CE-IP20
- Vitesse de coulissement 8cm/s
- Canal de glissement mm. 6
- Couleurs disponibles:
 - ◆ Poudre PAINT à base de résines de polyester approuvée par la marque QUALICOAT WHITE RAL 9010
- Poulies guide-ruban avec base en laiton.
- Ruban mm.10
- Chevauchement en acier par cm. 9
- Accessoires acétaliques autolubrifiants

Colori

colours / couleurs

 101 Bianco / White / Blanc

Misure

profiles / mesures

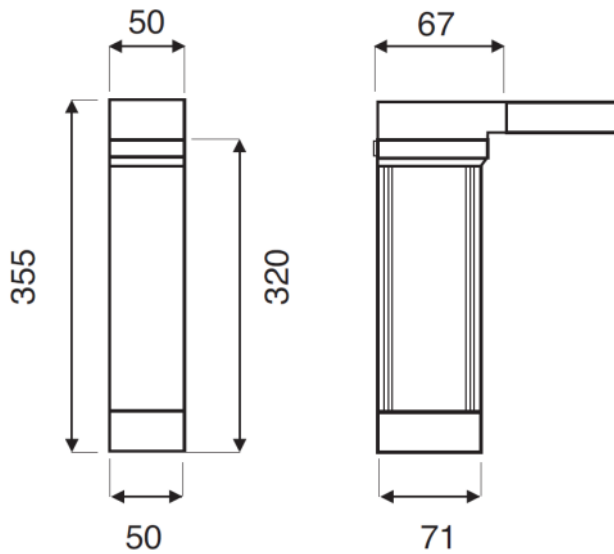
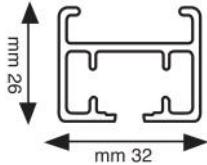

Portata

maximum load / gamme

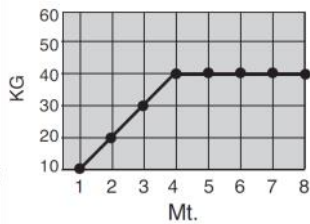

Alimentazione

Supply / Alimentation

Con cavo EU

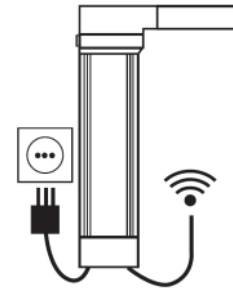

Scorrevoli

sliders / glisseurs

Art.3688



Accessori e Aperture Onda

Accessories and opening options for wave curtains / Accessoires et ouvertures pour Wave

Art.3266



Art.3223

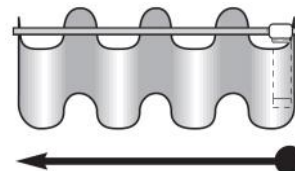

APL-DX

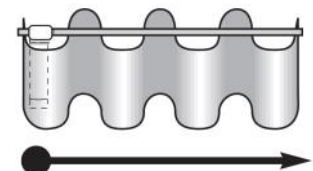

APL-SX

SX

DX

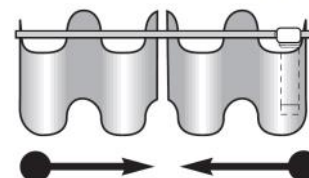

APC-P

Comandi

Controls / Commandes

Tocca e Vai / Touch & Go



Art.3106 - Pulsante
Switch / Bouton

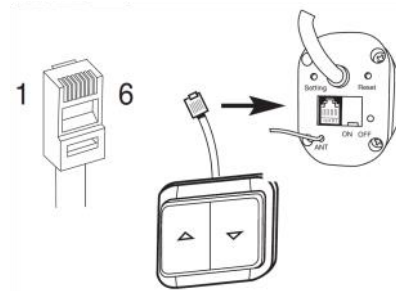

Art.3692 Telecomando radio a parete per 1 tenda
Wall remote-control for 1 curtain
Télécommande radio à paroi 1 rideau



Art.3691 Telecomando radio per 1 tenda
Remote control - 1 curtain
Télécommande radio - 1 rideau

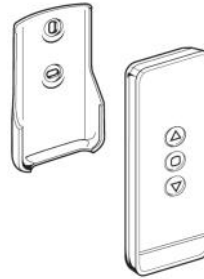

Art.3695 Telecomando radio per 5 tenda
Remote control - 5 curtain
Télécommande radio - 5 rideau

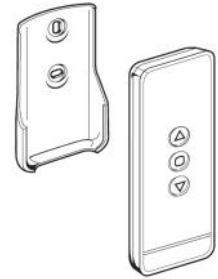

Art. 3693 - Ricevitore RF per contatti puliti. SOMFY
RF receiver for SOMFY dry contacts
Récepteur RF pour contacts secs SOMFY

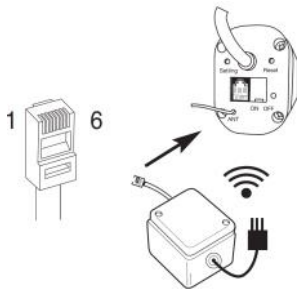

Art. 3613 - Telecomando a parete
Wall remote-control
Télécommande à paroi



Art.3211 - 3214 - 3619 - Telecomandi
Remote-controls / Télécommandes



Installazioni fixing / installations

Installazione a soffitto / ceiling fixing / au plafond

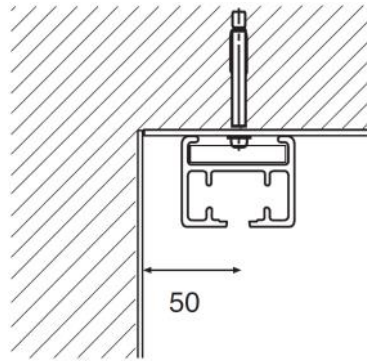

Installazione a parete / wall fixing / au mur

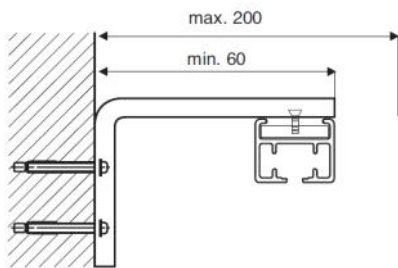

Art. 2721+2723+3690

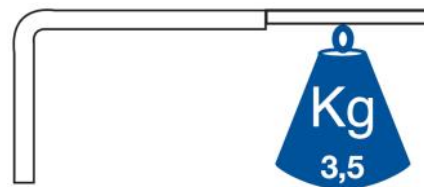
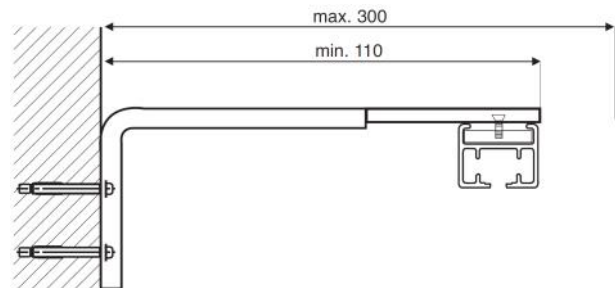

Art. 2721+2714+3690

Esploso

exploded view / vue éclatée

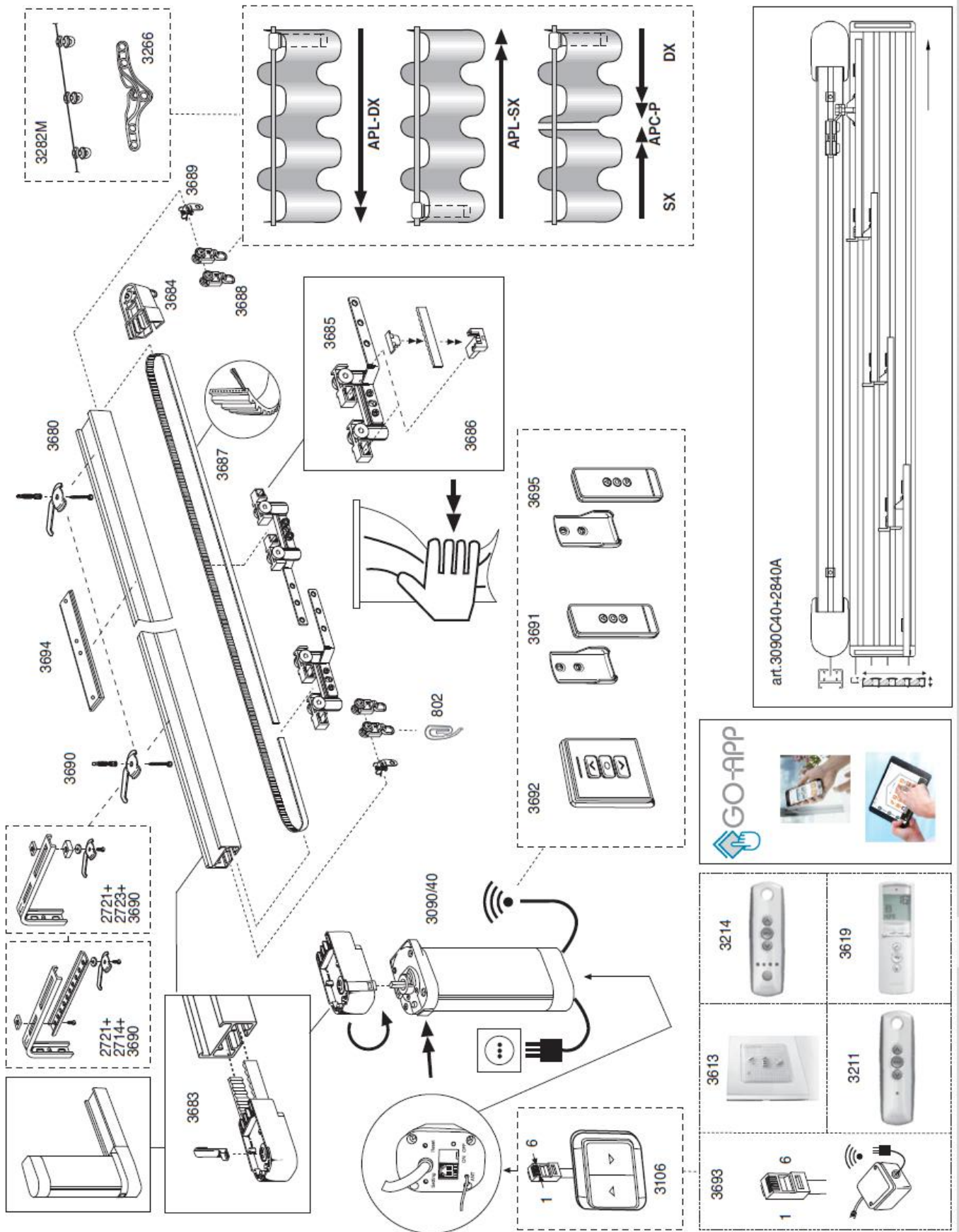



TENDE INTERNE ED ESTERNE

Rilox Italia Srl - Cap. Soc. €150.000,00 I./V.

Via Cascina Borniola, 15/A - 10036 Settimo Torinese (TO) - ITALY
Reg. Imprese Torino - C.F. - P. IVA - 10634150014 - R.E.A. 1149982

Ufficio Registro TORINO 2 - PEC: riloxitalia@pec.it

Tel:(+39) 011 262 5473 - Fax: (+39) 011 22 22 250

www.riloxitalia.it



@rilox.italia



#riloxitalia