



*Hi-tech system*  
**SET 2840**



Sistema per tende a pannelli.

Le tende a pannello sono ideali per ambienti con uno stile moderno e minimalista, particolarmente indicate per superfici grandi come ampie vetrate o finestre.

La semplicità dei pannelli può essere abbinata a molteplici tessuti, ognuno dei quali potrà dare una sfaccettatura e uno stile differente all'intero ambiente.



Panel curtain system.

Panel curtains are an ideal solution for modern and minimalist interiors, especially convenient for large surfaces as extended glass walls and widows.

Its panels' simplicity can easily be paired with various fabrics, all of which can lend a different undertone and style to the whole space.



Système de parois japonaises.

Les parois japonaises sont idéaux pour des environnements avec un modèle moderne et minimaliste, particulièrement approprié pour des surfaces aussi grandes que de grandes fenêtres.

La simplicité des panneaux peut être combinée avec plusieurs tissus, dont chacun peut donner une facette différente et le style à l'environnement tout entier.

# SISTEMA PER TENDE A PANNELLO

## PANEL CURTAIN SYSTEM

### SYSTÈME POUR PAROIS JAPONAISES

#### Utilizzo

- Sistema per tende a pannello
- Azionamento: con corde, a strappo o con asta
- Indicato per tendaggi di larghezza massima cm. 600
- Apertura tende: centrale, laterale e asimmetrica
- Il sistema di scorrimento delle corde è situato in canali indipendenti e paralleli ai teli
- Il sistema è indicato per installazioni a soffitto o a parete
- Lo scorrimento è garantito da rotelle calibrate autolubrificanti

#### Use

- Panel curtain system
- Operation: cords, hand drawn or rod
- Suitable for curtains up to cm 600 width
- Opening can be: central, lateral and asymmetrical
- The operating cords run in independent channels, parallel to panels
- It can be fixed both at the ceiling or at the wall
- Sliding guaranteed by calibrated self-lubricating gears

#### Utilisations

- Système de parois japonaises
- Actionnement : avec cordes, manuel ou par tige
- Convient pour rideaux de largeur maximale cm. 600
- Ouverture du rideau : centrale, latérale et asymétrique
- Le système de glissement de chaîne est situé dans des canaux indépendants parallèles aux tissus
- Le système convient pour installations au plafond et au mur
- Le défilement est garanti par des roues calibrées autolubrifiantes

#### Caratteristiche tecniche

- Profilo in lega d'alluminio estrusa 6060 T5 UNI EN 755-9
- Dimensioni: 2 vie 16,5 x 41 mm/ 3 vie 16,5 x 61 mm/ 4 vie 16,5 x 81 mm/ 5 vie 16,5 x 101 mm
- Canale di scorrimento 6 mm.
- Colori disponibili:
  - ◆ verniciatura a polvere a base di resine poliesteri omologata a marchio QUALICOAT BIANCO RAL 9010
  - ◆ lucidatura effetto Inox con ossidazione neutra di protezione
- Tappo terminale in acetalica antiurto con inserto guida corde
- Accessori in acetalica autolubrificante
- Portatelo in lega d'alluminio estrusa 6060 T5 UNI EN 755-9 con Velcro® adesivo (bloccato su tutta la lunghezza)
- PVC antiurto con Velcro® adesivo termosaldato
- Pesotenda in lega d'alluminio estrusa 6060 T5 UNI EN 755-9

#### Technical features

- Profile made of extruded aluminium alloy 6060 T5 UNI EN 755-9
- Size: 2-way 16,5 x 41mm/ 3-way 16,5 x 61mm/ 4-way 16,5 x 81mm/ 5-way 16,5 x 101mm
- Sliding channel 6 mm
- Available colours:
  - ◆ Powder coating with polyester resins, homologated QUALICOAT white RAL 9010
  - ◆ Inox effect polishing with protective neutral oxidation
- Endcup in acetalic resin, with cords guide insert
- Accessories in self-lubricating acetal resin
- Panel holder extruded aluminium alloy 6060 T5 UNI EN 755-9 with adhesive Velcro® (fixed all the length through)
- Shockproof PVC with heat-sealed adhesive Velcro®
- Curtain weight made of extruded aluminium alloy T5 UNI EN 755-9

#### Spécifications

- Profil en alliage d'aluminium extrudé 6060 T5 UNI EN 755-9
- Taille: 2 façons 16.5 x 41mm/3 façons 16.5 x 61mm/4 façons 16.5 x 81mm /5 façons 16.5 x 101mm
- Canal de glissement 6mm
- Couleurs disponibles:
  - ◆ peinture en poudre à base de résines de polyester approuvée par la marque QUALICOAT WHITE RAL 9010
  - ◆ polissage inoxydable avec oxydation neutre protectrice
- Casquette terminale acétate à l'épreuve des chocs avec insert de guide de chaîne
- Accessoires acétaliques autolubrifiants
- Portatelo en:
  - Alliage d'aluminium extrudé T5 UNI EN 755-9 avec adhésif Velcro® (verrouillé sur toute la longueur)
  - Choc PVC avec Velcro® l'adhésif chauffé
  - Poids en alliage d'aluminium extrudé 6060 T5 UNI EN 755-9

## Colori

colours / couleurs



101 Bianco / White / Blanc



106 Inox

## Misure profili

profiles sizes / mesures des profils

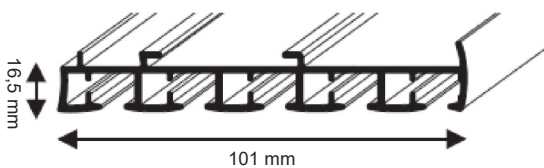
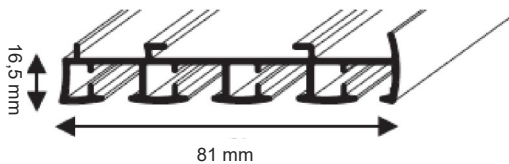
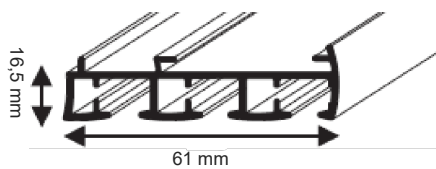
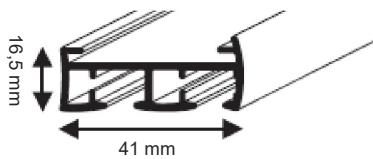

3 vie + 3 vie

3 vie + 4 vie

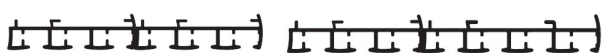

4 vie + 4 vie



## Portatelo e pesotenda

Aluminium rail and curtain weight / Profil avec Velcro et poids inférieur

Portatelo in lega d'alluminio

Portatelo in PVC

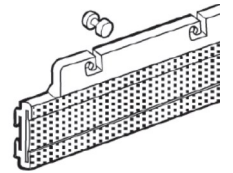
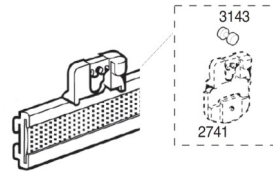

Pesotenda



## Soluzioni di utilizzo

Application solutions / Solutions d'emploi

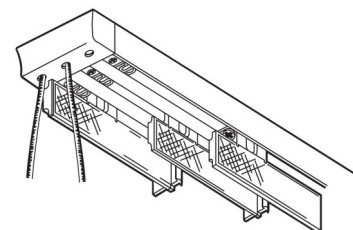
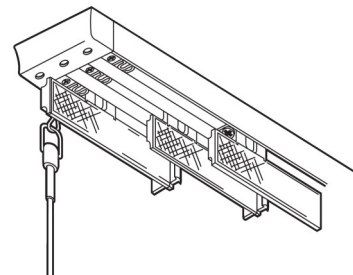
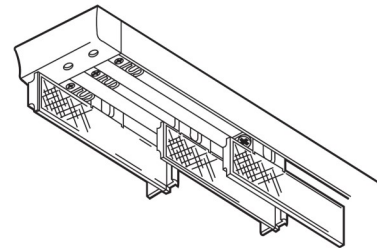

Optional doppia apertura (solo 5 vie)

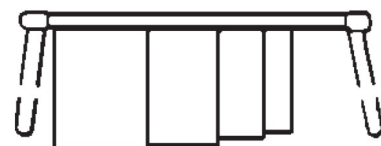

## Installazioni fixing / installations

Installazione a soffitto / ceiling fixing / au plafond

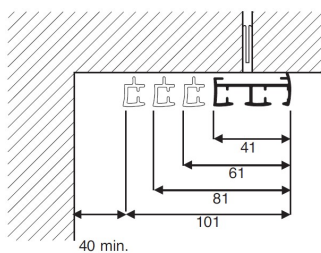

Art. 2740

Installazione a parete / wall fixing / au mur

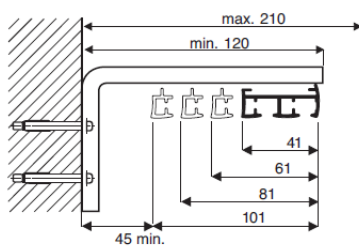

Art. 2721+2723+2740

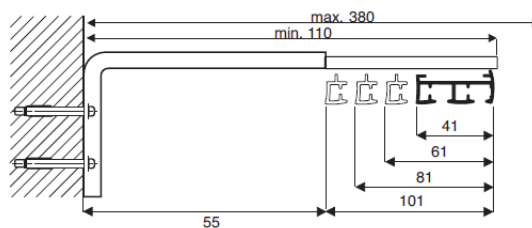

Art. 2721+2714+2740

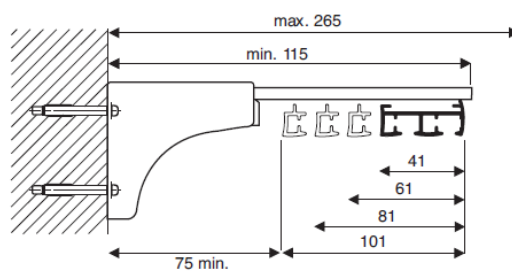

Art. 2713+2714+2740

SET 2840 + GO-RAIL

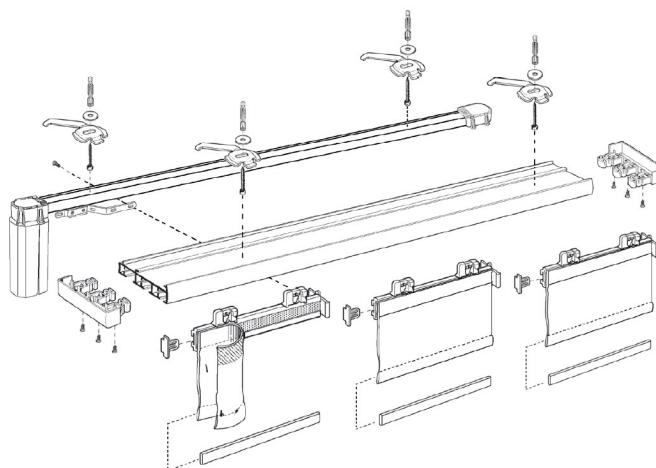

## Esploso

exploded view / vue éclatée

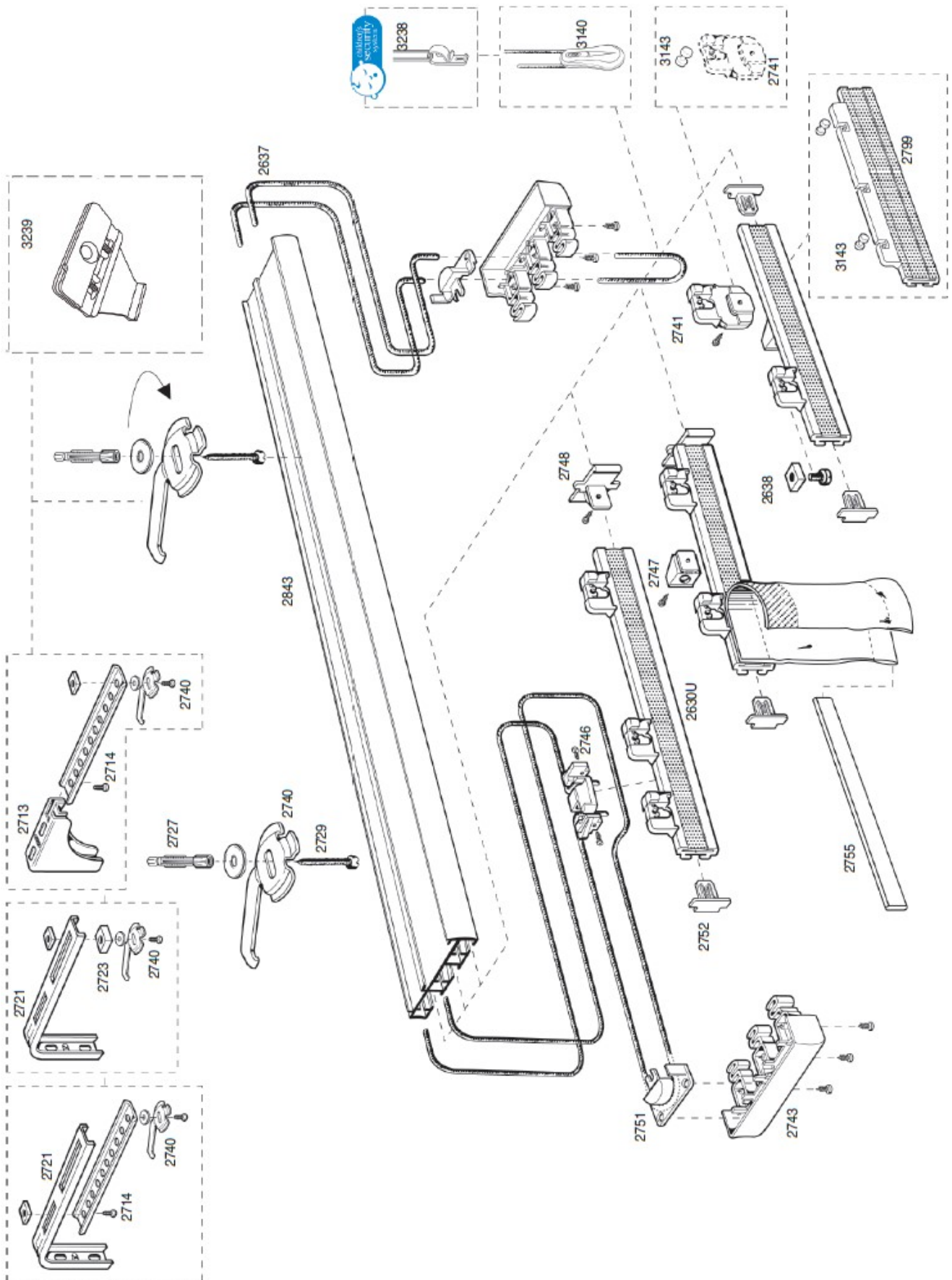



TENDE INTERNE ED ESTERNE

**Rilox Italia Srl** - Cap. Soc. €150.000,00 I./V.

Via Cascina Borniola, 15/A - 10036 Settimo Torinese (TO) - ITALY  
Reg. Imprese Torino - C.F. - P. IVA - 10634150014 - R.E.A. 1149982

Ufficio Registro TORINO 2 - PEC: riloxitalia@pec.it

Tel:(+39) 011 262 5473 - Fax: (+39) 011 22 22 250

[www.riloxitalia.it](http://www.riloxitalia.it)



@rilox.italia



#riloxitalia