

Hi-tech system
FREE 2820C



Sistema a corde libere, curvabile solo se a strappo, consigliato per l'applicazione di tende arricciate medie o semipesanti. L'installazione è a soffitto, a parete, con sistema pratico o in libera sospensione.

Il sistema Free può essere utilizzato per l'applicazione di tende per doccia, per realizzare separazioni di ambienti o per la sospensione di quadri.

Il profilo Free è inoltre disponibile nella versione velcrata, per l'applicazione di mantovane e tende, oppure tende leggere con mantovana.



Free cords system, suitable for hanging middle or middle-heavy curtains. Only the hand operation version is bendable. Mounting can be at ceiling, at the wall, with the up&down device or suspended with tie rods.

The system Free can also be used for hanging shower curtains, as room divider system or as pictures hanging system.

Free is also available with Velcro, for hanging valances and light curtains.



Système à cordes libres, courbé seulement en cas d'actionnement manuel, recommandé pour l'application de rideaux courbés moyens ou semi-lourds. L'installation est au plafond, mur, avec système pratique ou en suspension libre.

Le système Free peut être utilisé pour l'application de rideaux de douche, pour faire des séparations d'environnements ou pour la suspension des peintures.

Le profil Free est également disponible dans la version veloutée, pour l'application de mantovane et rideaux, ou rideaux légers avec cantonnières.

SISTEMA PER TENDE ARRICCIATE MEDIE O SEMIPESANTI

System for middle heavy draped curtains

Mécanisme pour rideaux froncés semi-lourds

Utilizzo

- Sistema per tende medie o semipesanti
- azionamento a strappo o con corde
- Indicato per tendaggi di larghezza massima cm. 600
- Apertura tenda centrale, laterale, multipla o asimmetrica
- Il sistema è indicato per installazioni sia a soffitto sia a parete
- Il sistema permette di realizzare curve a 90°, centine ad ampio raggio, curve miste (solo per sistema a strappo)
- Lo scorrimento è garantito da scivoli autolubrificanti in HDPE polietilene

Use

- System for light or middle draped curtains
- Hand or cord operation
- Suitable for curtains up to cm 600 width
- Opening can be: central, lateral, multiple or asymmetrical
- It can be fixed both at the ceiling or at the wall
- The cord sliding system in independent channels allows to realize 90° curves, big radius curves or mixed curves (for hand operation only)
- Sliding is guaranteed by self-lubricating sliders in polyethylene HDPE.

Utilisations

- Système de rideau moyen ou semi-lourd
- Entraînement manuel ou par corde
- Convient aux rideaux de largeur maximale cm. 600
- Ouverture centrale, latérale, multiple ou asymétrique du rideau d'aliét
- Le système convient aussi bien aux installations de plafond et de mur
- Le système vous permet de faire des courbes de 90 degrés, large gamme, courbes mixtes (seulement pour le système d'actionnement manuel)
- Le glissement est garanti par des toboggans autolubrifiants dans le HDPE en polyéthylène

Caratteristiche tecniche

- Profilo in lega d'alluminio estrusa 6060 T5 UNI EN 755-9
- Dimensioni mm. 15x23
- Canale di scorrimento mm. 6
- Raggio di curvatura (solo per sistema a strappo):
 - ◆ r = cm. 12 per curva a 90°
 - ◆ r = cm. 50 per curva ad ampio raggio
- Colori disponibili:
 - ◆ verniciatura a polvere a base di resine poliesteri omologata a marchio QUALICOAT RAL 9010
- Carrucole in acetalica con perni in acciaio
- Sormonto in acetalica da cm. 7
- Accessori in acetalica autolubrificante

Technical features

- Profile made of extruded aluminium alloy 6060 T5 UNI EN755-9
- Size mm. 15x23
- Sliding channel mm. 6
- Curve radius: (for hand operation only)
 - ◆ r = cm. 12 for 90° curve
 - ◆ r = cm. 50 for big radius curve
- Available colours:
 - ◆ Powder coating with polyester resins, homologated QUALICOAT white RAL 9010
- Pulleys in acetalic resin with steel pins
- 7cm acetal resin overlap
- Accessories in self-lubricating acetal resin

Spécifications

- Profil en alliage d'aluminium extrudé 6060 T5 UNI EN 755-9
- Taille mm. 15x23
- faire défiler le canal mm. 6
- Rayon de distorsion (pour le système d'actionnement manuel seulement) :
 - ◆ r = cm. 12 par courbe de 90 degrés
 - ◆ r = cm. 50 pour la courbe large-gamme
- Couleurs disponibles:
 - ◆ Peinture en poudre à base de Vester approuvée par QUALICOAT RAL 9010
- Carrucole en acétalc avec des goupilles en acier
- Chevauchement en acétalique par cm. 7
- Accessoires acétaliques autolubrifiants

Colori

colours / couleurs



101 Bianco / White / Blanc

Misure profili

profiles sizes / mesures des profils

Profilo FREE

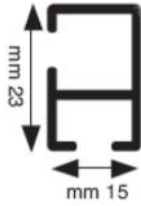

Portata

maximum load / gamme

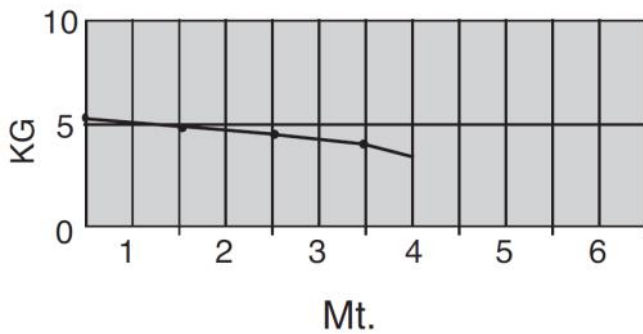

Scivoli e scorrevoli

sliders / glisseur

Art. 3141



Art. 3146



Art. 2624



Art. 3220-3223



Soluzioni di utilizzo

Application solutions / solutions d'emploi

D

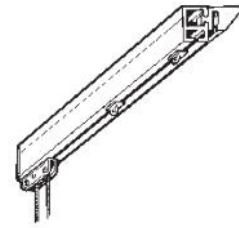

P

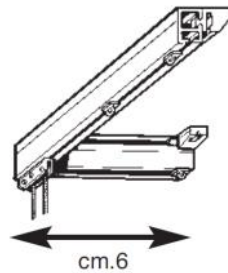

C

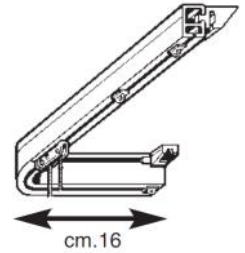

P

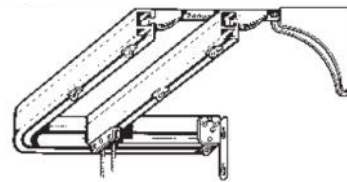

C

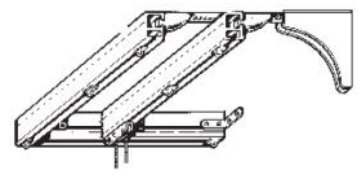

CN-I



CN-E



CN-IE

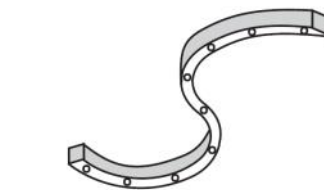

CN-A

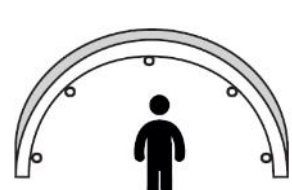

Installazioni fixing / installations

Installazione a soffitto / ceiling fixing / au plafond

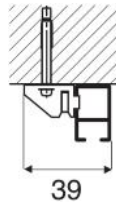

Art. 2711

Installazione a parete / wall fixing / au mur

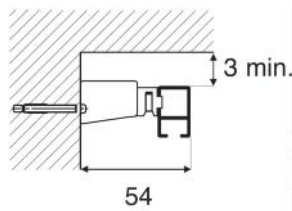

Art. 2712+2711

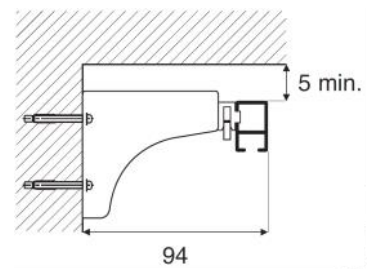

Art. 2713 + 2711

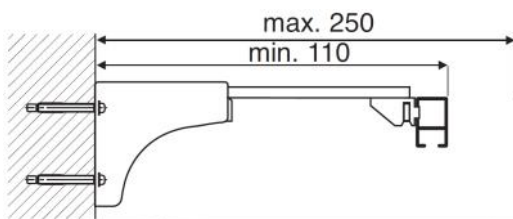

Art. 2713-2714-2711

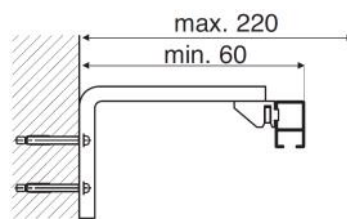

Art. 2721-2723-2711

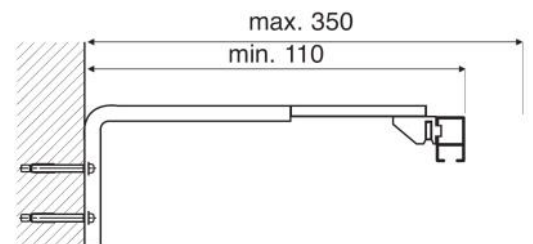

Art.2721-2714-2711

Installazione con kit saliscendi Pratico / with up-down system Pratico / avec de haut en bas kit Pratico

Soffitto / ceiling / plafond

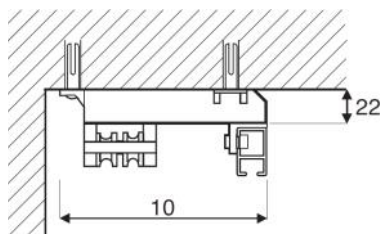

Art.1665 Pratico

Parete / wall / mur

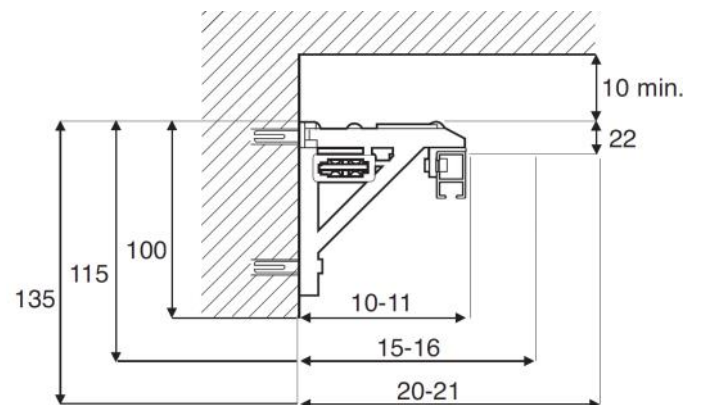

Art.1665 Pratico



TENDE INTERNE ED ESTERNE

Rilox Italia Srl - Cap. Soc. €150.000,00 I./V.

Via Cascina Borniola, 15/A - 10036 Settimo Torinese (TO) - ITALY
Reg. Imprese Torino - C.F. - P. IVA - 10634150014 - R.E.A. 1149982
Ufficio Registro TORINO 2 - PEC: riloxitalia@pec.it
Tel:(+39) 011 262 5473 - Fax: (+39) 011 22 22 250

www.riloxitalia.it



@rilox.italia



#riloxitalia