



GoGarden

Hi-tech system

3082C20



Go-Garden 3083C20 è il sistema con comando a motore studiato per lucernai, giardini d'inverno, vetrate inclinate o orizzontali, curve o centinate. Progettato per ambienti interni, è stato studiato per sorreggere schermature fino a 20 kg grazie alla presenza di guide laterali parallele.

Per adattarsi al meglio a più tipi di arredamento, è possibile scegliere tra una versione tesa (indicato per ambienti più minimal-chic) e una versione drappeggiata per ambienti più classici e senza tempo.

È possibile montare Go-Garden a qualsiasi inclinazione e altezza, così come scegliere un'apertura centrale o laterale.

Go-Garden 3083C20 monta un motore Somfy che permette una semplice installazione e la regolazione elettronica di finecorsa. È inoltre compatibile con la maggior parte dei sistemi di domotica attualmente disponibili ed è, in aggiunta, possibile scegliere l'azionamento tramite telecomando a radiofrequenza oppure attraverso l'innovativo sistema di automazione Go-App.



Go-Garden 3082C20 is a motorized system designed for skylights, wintergardens, sloped and horizontal windows, both straight and bent. Suitable for indoor, thanks to its parallel side guides it can hold up to 20kg fabrics.

To adapt to any environment, two models are available: one with straight fabric (suitable for minimal-chic environments) and the other with draped fabric, for a classical and timeless style.

Go-Garden 3083C20 is equipped with a Somfy motor that allows an easy installation and an automatic regulation of the end-run positions. It is also compatible with most of the smart home systems currently available on the market, and it can be operated through an RF remote-control or through the innovative Go-App.



Le Go-Garden 3082C20 est un système motorisé étudié pour la couverture de lucarnes, jardins d'hiver, verrières inclinées ou horizontales, courbées ou cintrées. Projeté pour l'intérieur, ce système peut soutenir un poids du tissu jusqu'à 20kg, grâce à ses guides latérales parallèles.

Pour mieux s'adapter à n'importe quel environnement, deux modèles sont disponibles : un avec toile étendue (adapté pour environnements minimal-chic) et l'autre avec toile drapée, pour environnements plus classiques et intemporel.

Le Go-Garden 3082C20 est équipé avec un moteur Somfy, qui permet une installation très simple et la régulation électronique du fin-de-course. Il est aussi compatible avec la plupart des systèmes domotiques disponibles sur le marché et il peut être actionné par télécommande à radiofréquence ou par l'innovatif système Go-App.

SISTEMA A MOTORE PER GIARDINI D'INVERNO FINO A 20kg

Motorized system for winter gardens up to 20kg

Système motorisé pour jardins d'hiver jusqu'à 20kg

■ ■ Utilizzo

- Sistema motore adatto per lucernai, vetrate orizzontali, pendenti, tetti di atrium e giardini d'inverno
- Il sistema è studiato per la copertura di superfici con lati paralleli
- Aperture laterali o centrali
- Motore Somfy AC 230V 50Hz
- Velocità di scorrimento 3cm al secondo
- Regolazione fincorsa elettronico
- Comandi con pulsante oppure con trasmettitore radio
- Compatibile con la maggior parte dei sistemi di domotica esistenti
- Comando a distanza con l'operazione GO-APP

■ ■ Use

- Motorized system suitable for skylights, horizontal, leaning and curved windows, atrium's ceilings and winter gardens
- This system was designed to cover surfaces with parallel sides
- Central or lateral opening
- Somfy motor AC 230V 50Hz
- Sliding speed 3cm/s...
- Electronic regulation of the end-run positions
- Switch- or remote-controlling
- Compatible with most of the currently available home-automation systems
- Remote operation through the Go-App

■ ■ Utilisations

- Système de moteur approprié pour puits de lumière, vitraux horizontaux, pendentifs, toits d'atrium et jardins d'hiver
- Le système est conçu pour couvrir les surfaces avec des côtés parallèles
- Ouvertures lateral ou centrales
- Moteur Somfy AC 230V 50Hz
- Vitesse de glissement de 3cm/s
- Régulation automatique du fin-de-course
- Actionnement par bouton ou par télécommande
- Compatible avec la plupart des systèmes domotiques existantes
- Actionnement à distance avec l'application GO-APP

■ ■ Caratteristiche tecniche

- Profilo, alberino di comando e carter di copertura in lega d'alluminio estrusa 6060 T5 UNI EN 755-9
- Dimensioni: profilo mm. 22x31 / carter mm70x70
- Tondini in alluminio diametro mm.12 o 15
- Portata massima tessuto 20 kg
- Dimensioni massime L=240 H=1000
- Dimensioni minime L=70
- Colori disponibili:
 - verniciatura a polvere a base di resine poliesteri omologata a marchio QUALICOAT BIANCO RAL 9010
- Carrucole per guida nastro con base in acciaio e ruote in acetalica su perni in acciaio
- Nastro di movimentazione mm. 10
- Accessori in acetalica autolubrificante
- Motori tradizionali o radio SOMFY

■ ■ Technical features

- Profile, rods and covering top made of extruded aluminium alloy 6060 T5 UNI EN 755-9
- Size: profile mm. 22x31 / covering top mm 70x70
- 12 or 15 mm rods
- Fabric's maximum weight 20 kg
- Maximum size L=240 H=1000
- Available colours:
 - Powder coating with polyester resins, homologated QUALICOAT white RAL 9010
- Steel pulleys for tape-guide with acetal resin roller on steel pins
- Drive-tape mm. 10
- Accessories in self-lubricating acetal resin
- Traditional or radio motors

■ ■ Spécifications

- Profil, tiges et couverture en alliage d'aluminium extrudé 6060 T5 UNI EN 755-9
- Taille: profil mm. 22x31 / couverture mm 70x70
- Tige en aluminium mm.12 ou 15
- Gamme maximale stoff 20 kg
- Taille maximale L=240 H=1000
- Couleurs disponibles:
 - Poudre PAINT à base de résines de polyester approuvée par la marque QUALICOAT WHITE RAL 9010
- Chariots de ruban adhésif avec base en acier et roues en acetalique sur des goupilles en acier
- Manipulation du ruban adhésif mm. 10
- Accessoires acétaliques autolubrifiants
- Moteurs traditionnels ou radio

Colori

colours / couleurs

 101 Bianco / White / Blanc

Misure profili

profiles sizes / mesures des profils

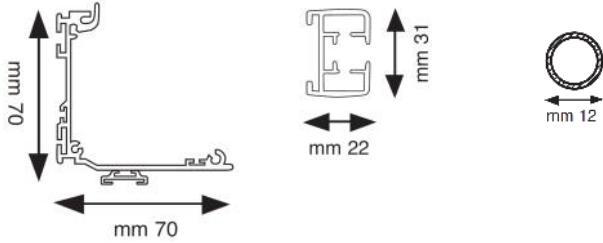

Portata

maximum load / gamme

D

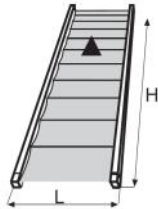

Max Kg.20

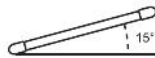

$> \text{Ø} \text{ e } < 15^\circ$

Max Kg.15

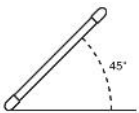

$> 15^\circ \text{ e } < 45^\circ$

Max Kg.8

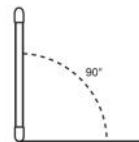

$> 45^\circ \text{ e } < 90^\circ$

Max Kg.6

C

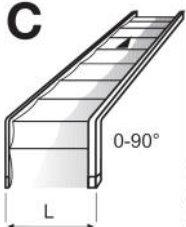

R. - 30 cm min.



Max Kg.8

CN

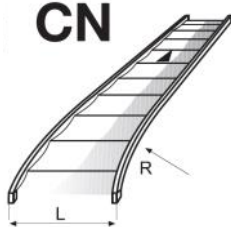

R. 100 cm min.



Max Kg.6

Scivoli

sliders / glisseurs

Art.3130

Per telo dritto



Art.3130 con fermo catena

Per telo drappeggiato

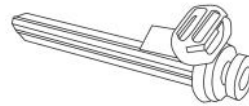

Aperture e comandi

Openings and Controls / Ouvertures et actionnement

Aperture laterali / lateral opening / Ouvertures lateral art.3129

A/1

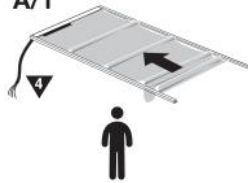

A/2



B/1

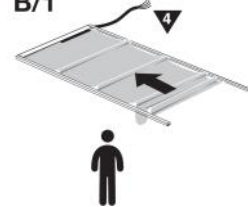

B/2

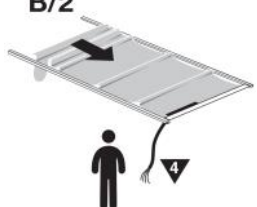

Aperture centrali / central opening / Ouvertures centrales art.3131

A/3

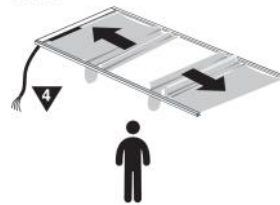

A/4

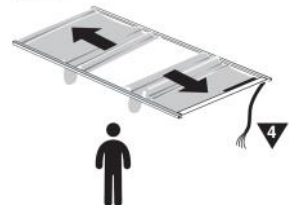

B/3

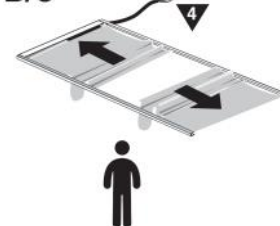

B/4

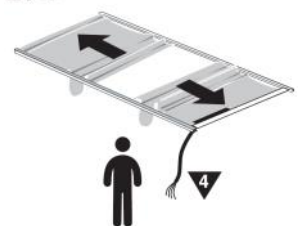

Comandi 3080C420

Controls / Commandes

Art.3082M6—Motori tradizionali SOMFY, comando in fase salita– discesa
Traditional motors, with up&down phase / Moteurs traditionnelles avec contrôle de phase montée-descente

Art.3612 - Interruttore
Wall mechanical switch
Bouton mécanique

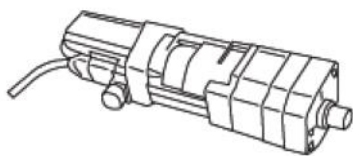

Art-3082R6 Motori radio Somfy
Radio motors / Moteurs radio

Art. 3613 - Telecomando a parete
Wall remote control
Télécommande à paroi a 1 canal

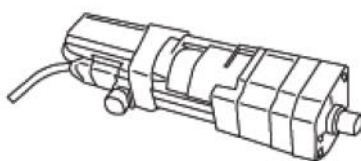

Art.3211-3214-3619 - Telecomandi
Remote-controls / Télécommandes



Art. CONNEXOON RTS
Controllo intelligente e gestione remota delle tende
Smart control and remote management of curtains and blinds
Contrôl intelligent et gestion à distance de rideaux et stores

Art. TAHOMA
Controllo e gestione remota della casa intelligente
Smart-home remote control and management
Gestion à distance de la maison intelligente



Installazioni fixing / installations

Installazione a parete / wall fixing / au mur

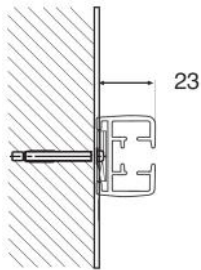

Art.3117

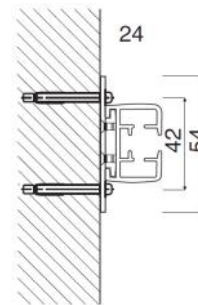

Art.3119

Installazione a soffitto / ceiling fixing / au plafond

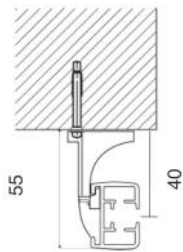

Art.3118

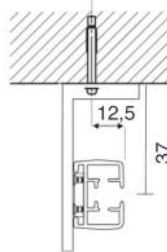

Art.3136

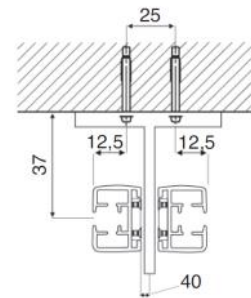

Art.3137

In aggiunta per apertura centrale / Additional for central opening / En plus pour ouvertures centrales

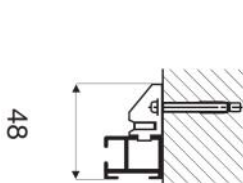

Art.2711

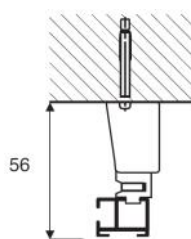

Art.2721+2711

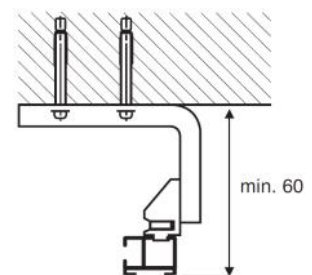

Art.2721+2723+2711

Esploso

exploded view / vue éclatée

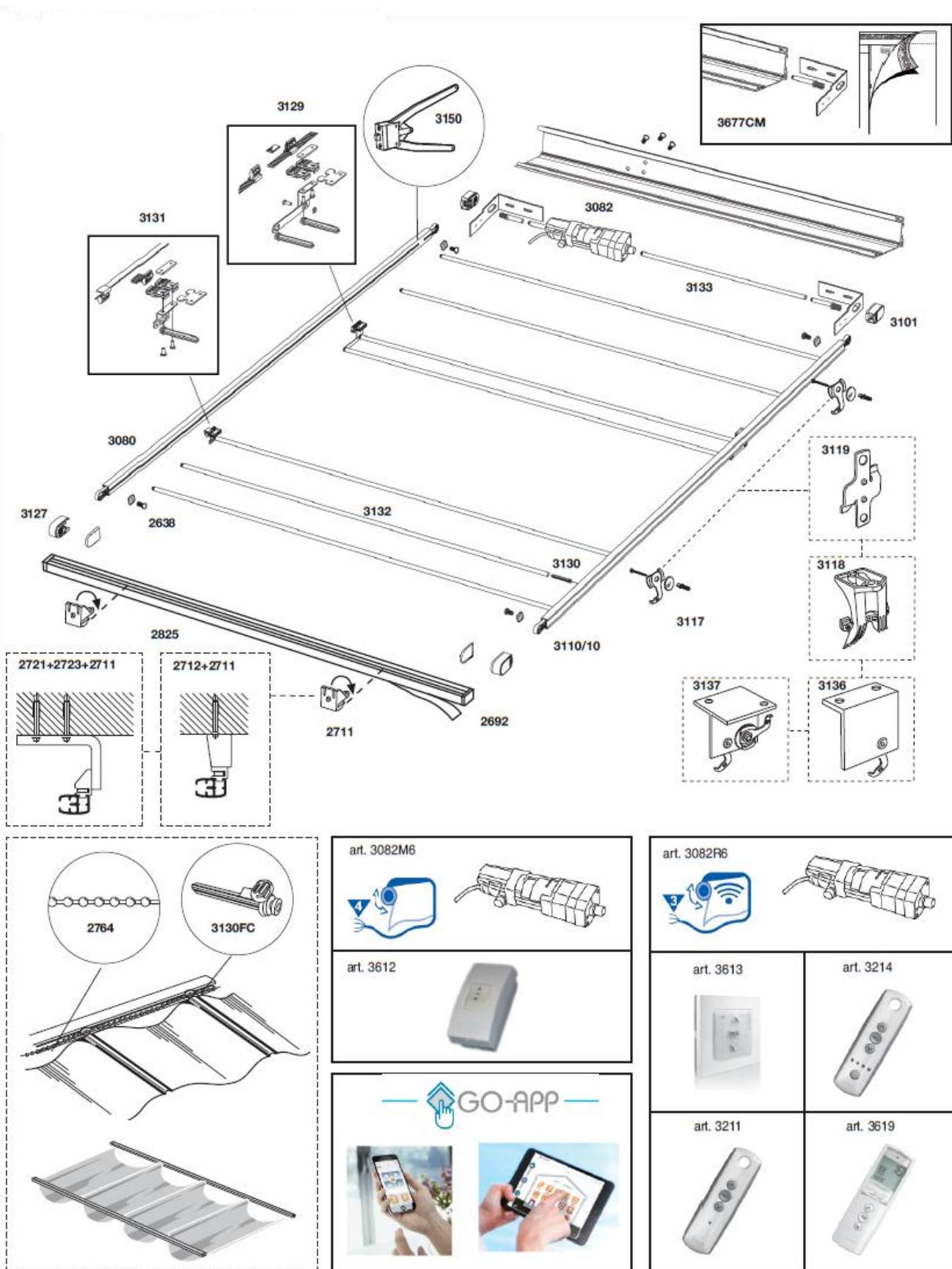



TENDE INTERNE ED ESTERNE

Rilox Italia Srl - Cap. Soc. €150.000,00 I./V.

Via Cascina Borniola, 15/A - 10036 Settimo Torinese (TO) - ITALY

Reg. Imprese Torino - C.F. - P. IVA - 10634150014 - R.E.A. 1149982

Ufficio Registro TORINO 2 - PEC: riloxitalia@pec.it

Tel:(+39) 011 262 5473 - Fax: (+39) 011 22 22 250

www.riloxitalia.it



@rilox.italia



#riloxitalia