



*Hi-Tech system*  
**FREE 2820CO**



Sistema a strappo o con corde libere (curvabile solo se a strappo), consigliato per l'applicazione di tende a onda medie o semi-pesanti.

L'installazione è a soffitto o a parete.

Le tende a onda, caratterizzate da un'omogeneità donata dal tessuto stesso, sono capaci di rinnovare ogni tipo di ambiente grazie al loro aspetto lineare e ordinato.

Free 2820CO è adatto ad ogni tipo di ambiente, dal più moderno al più classico, e può essere utilizzato per realizzare separazioni di ambienti.



Free cords system, suitable for hanging middle or middle-heavy curtains. Only the hand operation version is bendable. Mounting can be at ceiling or at the wall.

Free 2820CO is suitable for any type of environment, from the most modern to the most classical, and it can also be used as a room-divider .



Système à cordes libres, courbé seulement en cas d'actionnement manuel, recommandé pour l'application de rideaux courbés moyens ou semi-lourds. L'installation est au plafond ou mur.

Le tende a onda, caractérisées par une homogénéité donnée par le tissu même, sont capables de renouveler tout type d'environnement grâce à leur aspect linéaire et ordonné.

Free 2820CO est adapté à tout type d'environnement, du plus moderne au plus classique, et peut être utilisé pour réaliser des séparations d'ambients.

La tringle Free 2820CO est adaptée pour n'importe quel type d'environnement, du plus moderne au plus classique, et elle peut aussi être utilisée pour la séparation de pièces.

# SISTEMA PER TENDE A ONDA

## System for wave curtains

## Système pour rideaux wave

### Utilizzo

- Sistema per tende a onda medie o semipesanti
- Azionamento a strappo o con corde libere
- Indicato per tendaggi di larghezza massima cm. 500
- Apertura tenda centrale e laterale
- Il sistema è indicato per installazioni sia a soffitto sia a parete
- Il sistema permette di realizzare curve a 90°, centine ad ampio raggio, curve miste (solo per sistema a strappo)
- Lo scorrimento è garantito da scivoli autolubrificanti in HDPE polietilene

### Use

- System for light or middle wave curtains
- Hand or cord operation
- Suitable for curtains up to cm 500 width
- Opening can be: central or lateral
- It can be fixed both at the ceiling or at the wall
- The cord sliding system in independent channels allows to realize 90° curves, big radius curves or mixed curves (for hand operation only)
- Sliding is guaranteed by self-lubricating sliders in polyethylene HDPE.

### Utilisations

- Système de rideau wave moyen ou semi-lourd
- Entraînement manuel ou par corde
- Convient aux rideaux de largeur maximale cm. 500
- Ouverture centrale ou latérale
- Le système convient aussi bien aux installations de plafond et de mur
- Le système vous permet de faire des courbes de 90 degrés, large gamme, courbes mixtes (seulement pour le système d'actionnement manuel)
- Le glissement est garanti par des toboggans autolubrifiants dans le HDPE en polyéthylène

### Caratteristiche tecniche

- Profilo in lega d'alluminio estrusa 6060 T5 UNI EN 755-9
- Dimensioni mm. 15x23
- Canale di scorrimento mm. 6
- Raggio di curvatura (solo per sistema a strappo):
  - ◆ r = cm. 12 per curva a 90°
  - ◆ r = cm. 50 per curva ad ampio raggio
- Colori disponibili:
  - ◆ verniciatura a polvere a base di resine poliesteri omologata a marchio QUALICOAT RAL 9010
- Carrucole in acetalica con perni in acciaio
- Sormonto in acetalica da cm. 7
- Accessori in acetalica autolubrificante

### Technical features

- Profile made of extruded aluminium alloy 6060 T5 UNI EN755-9
- Size mm. 15x23
- Sliding channel mm. 6
- Curve radius: (for hand operation only)
  - ◆ r = cm. 12 for 90° curve
  - ◆ r = cm. 50 for big radius curve
- Available colours:
  - ◆ Powder coating with polyester resins, homologated QUALICOAT white RAL 9010
- Pulleys in acetalic resin with steel pins
- 7cm acetal resin overlap
- Accessories in self-lubricating acetal resin

### Spécifications

- Profil en alliage d'aluminium extrudé 6060 T5 UNI EN 755-9
- Taille mm. 15x23
- faire défiler le canal mm. 6
- Rayon de distorsion (pour le système d'actionnement manuel seulement) :
  - ◆ r = cm. 12 par courbe de 90 degrés
  - ◆ r = cm. 50 pour la courbe large-gamme
- Couleurs disponibles:
  - ◆ Peinture en poudre à base de Vester approuvée par QUALICOAT RAL 9010
- Carrucole en acétalc avec des goupilles en acier
- Chevauchement en acétalique par cm. 7
- Accessoires acétaliques autolubrifiants

## Colori

colours / couleurs



101 Bianco / White / Blanc

## Misure profili

profiles sizes / mesures des profils

Profilo FREE

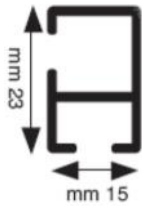

## Soluzioni di utilizzo

Application solutions / Solutions d'emploi

D

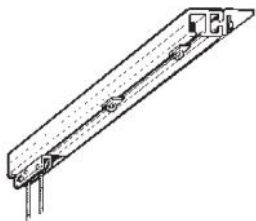

CN-I

C

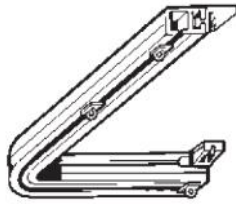

CN-E

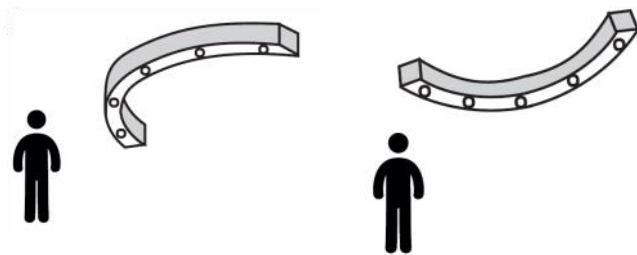

CN-I+E+IE

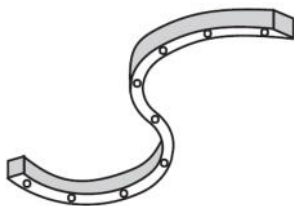

## Accessori

Accessories / Accessoires

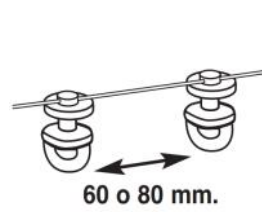

Art. 3220 - 3282 - 3223

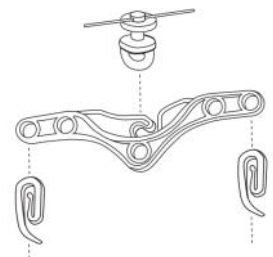

Art. 3266

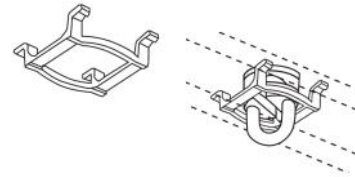

Art.3264

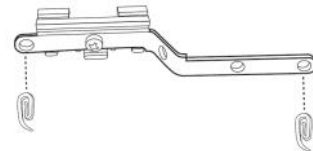

Art.2684

## Aperture

Openings / Ouverture

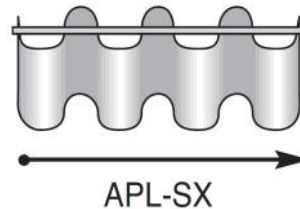

APL-SX

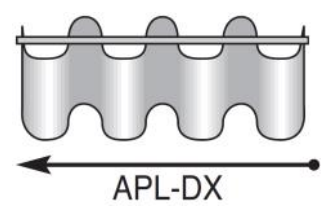

APL-DX

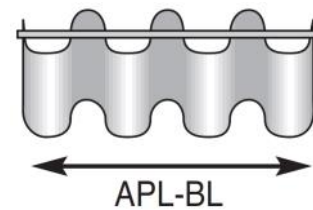

APL-BL

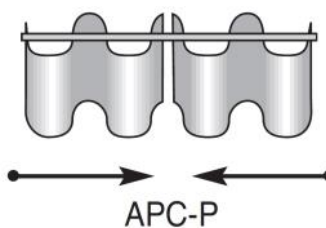

APC-P

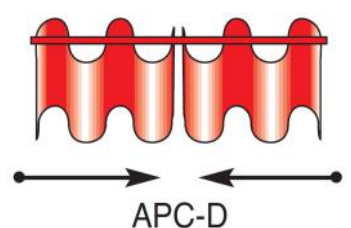

APC-D

# Installazioni

fixing / installations

Installazione a soffitto / ceiling fixing / au plafond

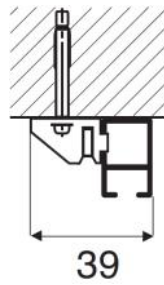

Art. 2711

Installazione a parete / wall fixing / au mur

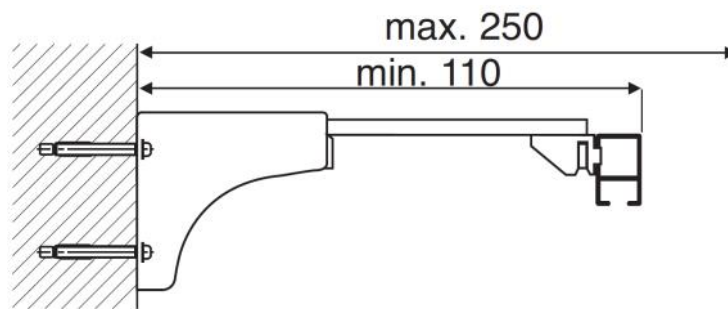

Art. 2713-2714-2711

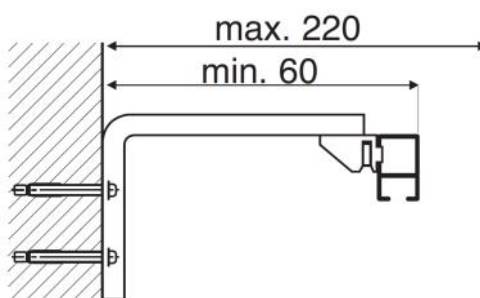

Art. 2721-2723-2711

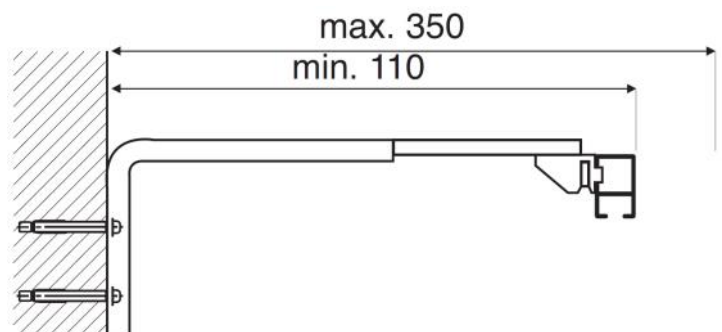

Art. 2721-2714-2711





TENDE INTERNE ED ESTERNE

**Rilox Italia Srl** - Cap. Soc. €150.000,00 I./V.

Via Cascina Borniola, 15/A - 10036 Settimo Torinese (TO) - ITALY  
Reg. Imprese Torino - C.F. - P. IVA - 10634150014 - R.E.A. 1149982  
Ufficio Registro TORINO 2 - PEC: riloxitalia@pec.it  
Tel:(+39) 011 262 5473 - Fax: (+39) 011 22 22 250

[www.riloxitalia.it](http://www.riloxitalia.it)



@rilox.italia



@riloxitalia