

Hi-tech system
EURO 2880CC



Sistema per tende arricciate con movimentazione a catenella, adatto per tendaggi semi-pesanti fino a 10kg, con larghezza max cm. 600.

Il sistema di scorrimento della catenella in canali indipendenti permette di realizzare: curve a 90°, centine ad ampio raggio o curve miste.

È possibile realizzare sistemi con apertura centrale, laterale, multipla o asimmetrica.

Altresi è possibile abbinare, tramite speciali supporti, profili velcrati per mantovane e/o calate.

Il sistema è progettato per installazioni sia a soffitto sia a parete.



System for middle-heavy draped curtains up to 10kg with chain operation. Suitable for curtains up to cm 600 width.

The chain sliding system in independent channels allows to realize 90° curves, big radius curves or mixed curves.

Sliding is guaranteed by self-lubricating sliders in polyethylene HDPE, or by roller sliders.

You can realize systems with central, lateral, multiple or asymmetrical opening.

Moreover it is possible to match, by means of special supports, profiles with Velcro for valances or side curtains.

The system is designed for ceiling or wall fixing.



Système pour rideaux francés semi-lourds jusqu'à 10kg avec manipulation à chaînette, approprié pour des rideaux avec la largeur maximale de cm. 600.

Le système d'entraînement à chaînette dans canaux indépendants vous permet de faire: courbes de 90 degrés, cents large gamme ou courbes mixtes.

Le glissement est garanti par des toboggans autolubrifiants en polyéthylène HDPE ou en glissant avec des roues.

Il est possible de créer des systèmes avec une ouverture centrale, latérale, multiple ou asymétrique.

Il est également possible de combiner, par le biais de médias spéciaux, des profils Velcrat pour les cantonnières et/ou les bas.

SISTEMA PER TENDE ARRICCIATE CON CATENELLA

Chain-operated system for draper curtains

Tringle à chainette pour rideaux froncés

Utilizzo

- Sistema per tende arricciate medio-pesanti fino a 10kg
- Azionamento a catena
- Indicato per tendaggi di larghezza massima cm. 600
- Apertura tenda centrale, laterale, multipla o asimmetrica
- Il sistema è indicato per installazioni sia a soffitto sia a parete
- Il sistema di scorrimento della catenella d'azionamento in canali indipendenti permette di realizzare curve a 90°, centine ad ampio raggio, curve miste

Use

- System for middle heavy draped curtains up to 10 kg
- Chain operated
- Suitable for curtains up to cm 600 width
- Opening can be: central, lateral, multiple or asymmetrical
- It can be fixed both at the ceiling or at the wall
- The chain sliding system in independent channels allows to realize 90° curves, big radius curves or mixed curves.

Utilisations

- Système pour rideaux froncés semi-lourds jusqu'à 10 kg
- Entraînement à chainette
- Convient pour rideaux de largeur maximale cm. 600
- Ouverture centrale, latérale, multiple ou asymétrique du rideau d'aliet
- Le système convient aussi bien aux installations au plafond et au mur
- Le système de glissement de chaîne d'entraînement dans les canaux indépendants vous permet de faire des courbes à 90 degrés, large-gamme, courbes mixtes

Caratteristiche tecniche

- Profilo in lega d'alluminio estrusa 6060 T5 UNI EN 755-9
- Dimensioni mm. 17x26
- Canale di scorrimento mm. 6
- Raggio di curvatura:
 - ◆ r = cm. 12 per curva a 90°
 - ◆ r = cm. 50 per curva ad ampio raggio
- Colori disponibili:
 - ◆ verniciatura a polvere a base di resine poliesteri omologata a marchio QUALICOAT BIANCO RAL 9010
 - ◆ anodizzato argento
- Carrucole in acciaio con ruote in acetalica su perni in acciaio
- Sormonto in acetalica da cm. 7
- Accessori in acetalica autolubrificante

Technical features

- Profile made of extruded aluminium alloy 6060 T5 UNI EN 755-9
- Size mm. 17x26
- Sliding channel mm. 6
- Curve radius:
 - ◆ r = cm. 12 for 90° curve
 - ◆ r = cm. 50 for big radius curve
- Available colours:
 - ◆ powder coating with polyester resins, homologated QUALICOAT white RAL 9010
 - ◆ anodized silver
- Steel pulleys with acetal resin roller on steel pins
- 7cm acetal resin overlap
- Accessories in self-lubricating acetal resin

Spécifications

- Profil en alliage d'aluminium extrudé 6060 T5 UNI EN 755-9
- Taille mm. 17x26
- Canal de glissement mm. 6
- Rayon de distorsion:
 - ◆ r = cm. 12 par courbe de 90 degrés
 - ◆ r = cm. 50 pour la courbe large-gamme
- Couleurs disponibles:
 - ◆ Poudre PAINT à base de résines de polyester approuvée par la marque QUALICOAT WHITE RAL 9010
 - ◆ argent anodisé
- Carpals en acier avec roues acétates sur les pointes dans le mal
- Chevauchement en acétalique par cm. 7
- Accessoires acétaliques autolubrifiants

Colori

colours / couleurs

 101 Bianco / White / Blanc

 100 Argento / Silver / Argent

Misure profili

profiles sizes / mesures des profils

Profilo Euro

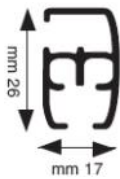

Scivoli e scorrevoli

sliders / glisseurs



Art. 3141

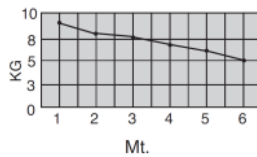

Art. 3146

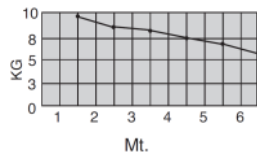

Art. 3144

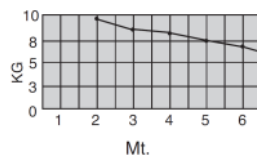

Soluzioni di utilizzo

Application solutions / Solutions d'emploi

D

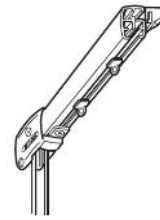

P

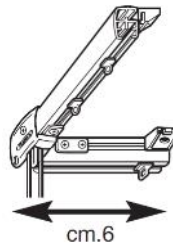

C

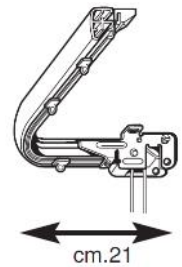

P+D

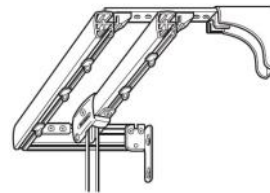

C+D

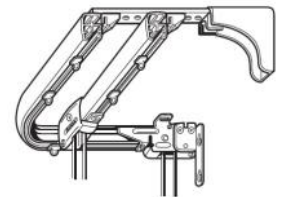

CN-I

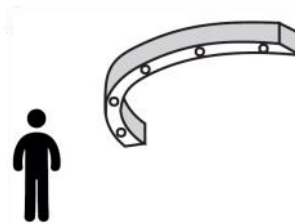

CN-E

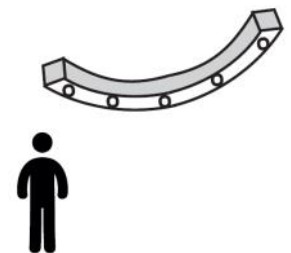

CN-IE

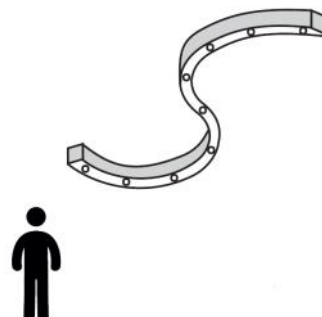

Art.3145

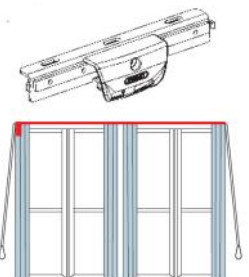

Installazioni fixing / installations

Installazione a soffitto / ceiling fixing / au plafond

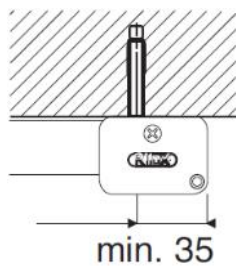

Art. 2710

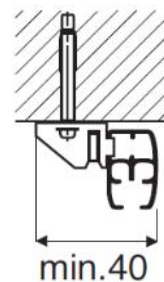

Art. 2711

Installazione a parete / wall fixing / au mur

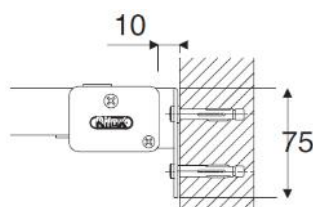

Art.2708

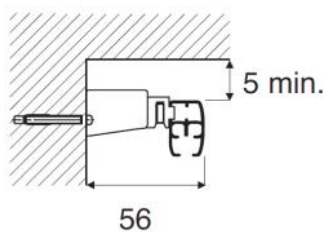

Art. 2712+2711

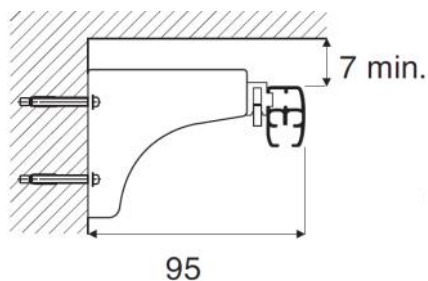

Art. 2713+2711

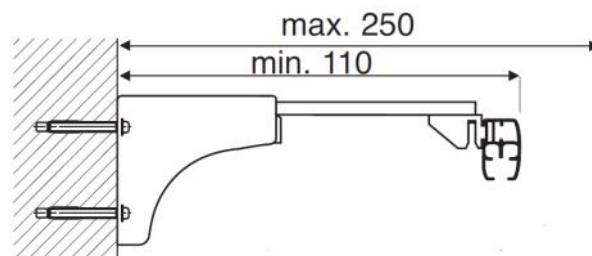

Art.2713+2714+2711

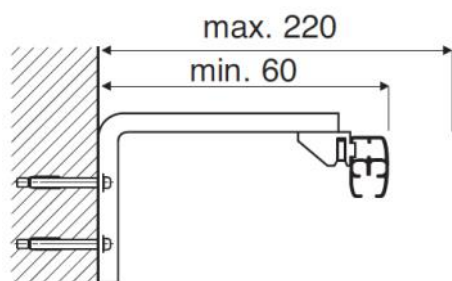

art.2721+2723+2711

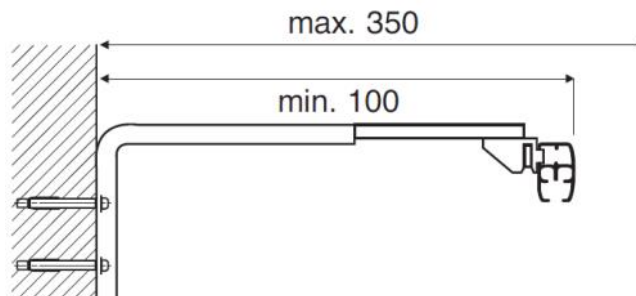

Art.2721+2714+2711

Esploso exploded view / vue éclatée

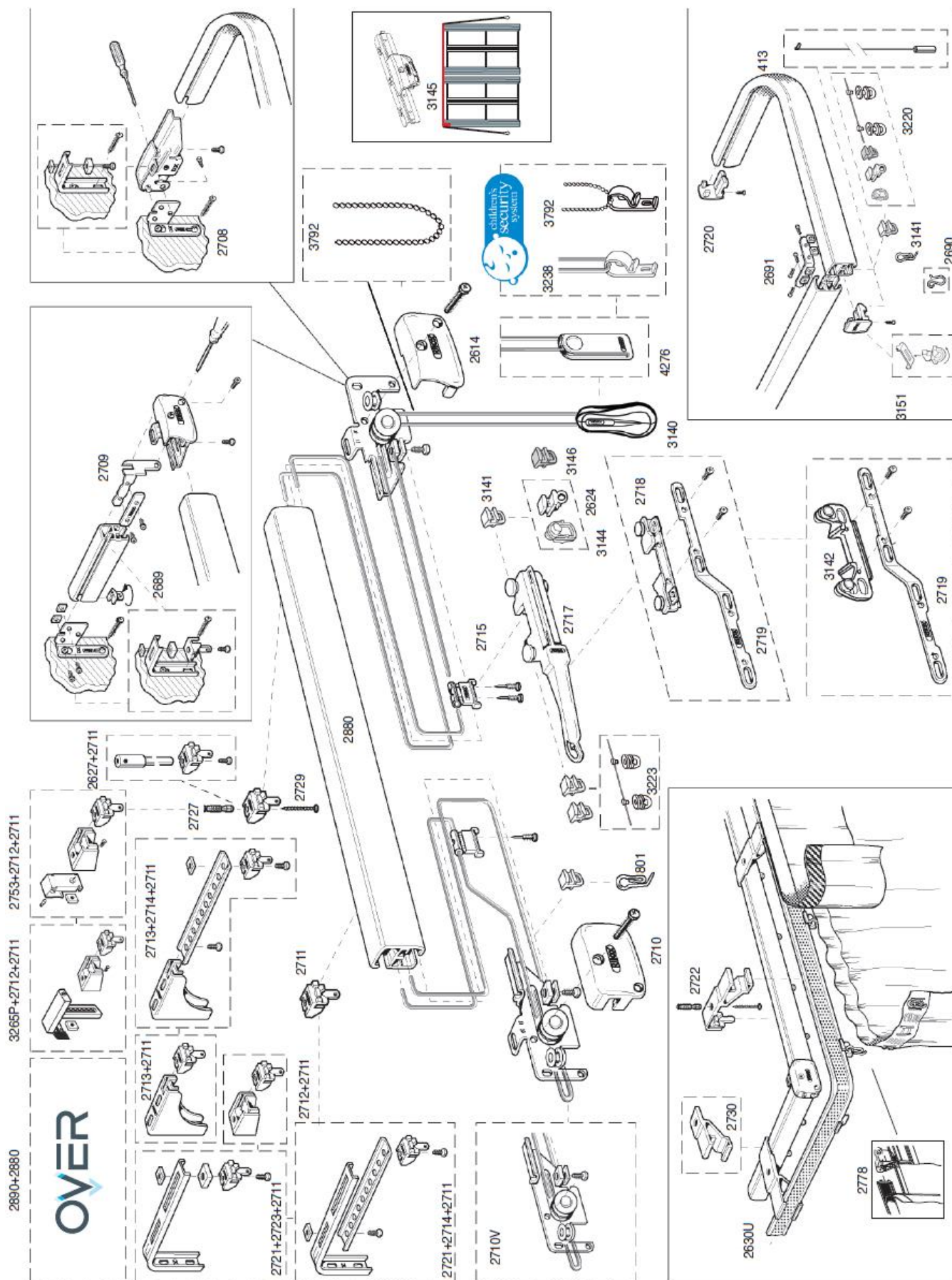



TENDE INTERNE ED ESTERNE

Rilox Italia Srl - Cap. Soc. €150.000,00 I./V.

Via Cascina Borniola, 15/A - 10036 Settimo Torinese (TO) - ITALY

Reg. Imprese Torino - C.F. - P. IVA - 10634150014 - R.E.A. 1149982

Ufficio Registro TORINO 2 - PEC: riloxitalia@pec.it

Tel:(+39) 011 262 5473 - Fax: (+39) 011 22 22 250

www.riloxitalia.it



@rilox.italia



#riloxitalia